

The logo for ALUMINUN, featuring the word in a bold, sans-serif font with a stylized white vertical bar in the letter 'U'.

ALUMINUN

The logo for ZHONGLIAN Aluminum Profiles, consisting of a stylized 'ZHG' symbol followed by the company name.

ZHONGLIAN
Aluminum Profiles



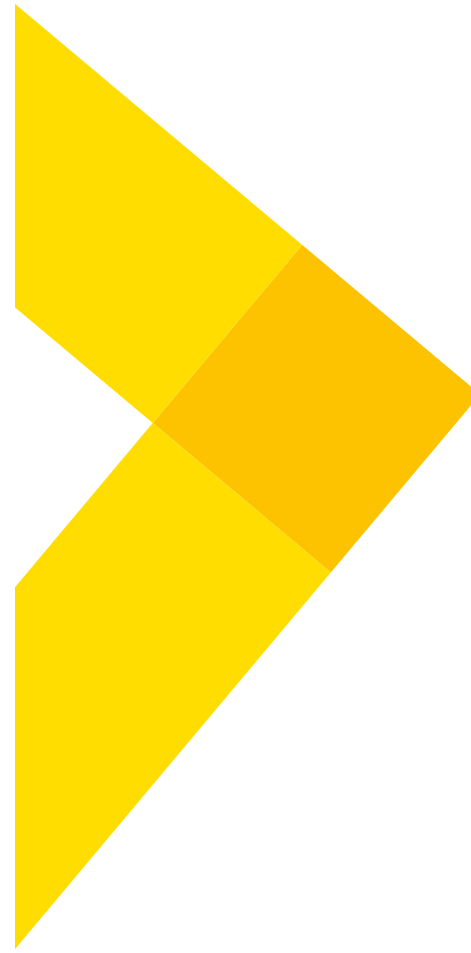

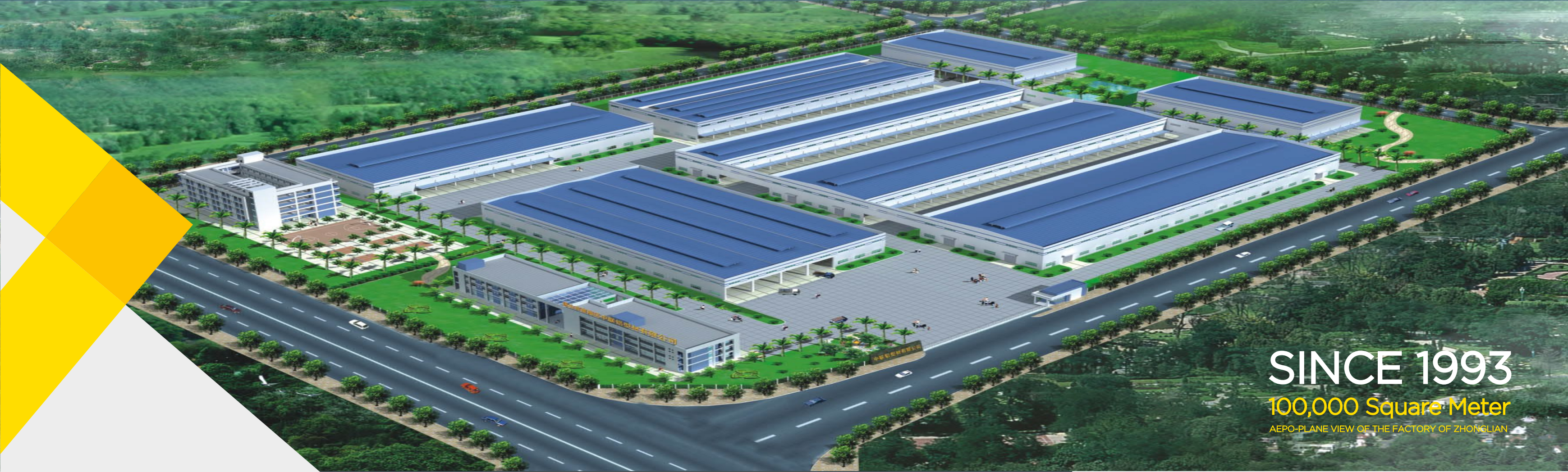

SINCE 1993
100,000 Square Meter
AEPO-PLANE VIEW OF THE FACTORY OF ZHONGLIAN

At ZHONGLIAN we build excellence every day!

Guangdong Zhonglian Aluminium Profiles Co., Ltd. is a large-scale comprehensive aluminum profile factory specializing in developing, designing and manufacturing aluminum extrusions. Occupying an area of 100 thousand square meters, we own 23 extrusion lines and a passionate 50 person team professional at foreign trade marketing.

With more than 30-years experience, our factory is already among China's advanced and leading companies in aluminum profile industry for architectural, decorative and industrial purposes. With an annual output of around 50 thousand tons, anodizing, powder coating, wooden grain color, electrophoresis, polishing and CNC profiles are our most popular and main hot selling products for all the time being.

We kept helping develop tailor made products to meet customers' unique demand, especially those require CNC hole punching, screwing, milling, precision cutting, piece powder coating and anodizing. Our factory has been equipped with a CNC machining center and imported high tech machines to provide great support for this. Unremitting self-improvement and pursuit of excellence is our belief. Keep this in mind, our factory has become a well-known brand name all around China and our profiles have been exported to more than 70 countries for now. Customers from all over the globe are always welcomed to come to our factory for a visit at any time.

Contents

03 - 14

Company Introduction

17 - 22

Team Member

23 - 28

Production Equipment

29 - 60

Custom Service Introduction

61 - 70

Certificate & Project Packaging and Shipping

71 - 120

Aluminum Products

INDEX

Company Profile.....	3-4
Development History.....	7-8
Technical Advantages.....	9-10
Company Brand.....	11-12
Team Advantages.....	13-14
CEO Profile.....	15-16
Team Member.....	17-22
Production Equipment.....	23-28
Custom Service.....	29-32
CNC Service.....	33-34
Product Range.....	35-36
Surface Treatment & Color.....	37-60
Honor & Certificate.....	61-62
Project Case & Clients.....	63-66
Packaging and Shipping.....	67-70

Aluminum Tubes & Pipes Series

In Stock Square Aluminum Tube	71-78
Ready Mold Square Aluminum Tube	79-82
In Stock Round Aluminum Pipe.....	83-86
Ready Mold Round Aluminum Pipe.....	87-88

Aluminum Angles & Channels

In Stock Aluminum Angles & Channels.....	89-92
Ready Mold Aluminum Angles & Channels.....	89-92

Aluminum Louvers & Shutters

Ready Mold Aluminum Louvers & Shutters.....	93-106
---------------------------------------------	--------

Machined & CNC Aluminium Profiles

Outdoor Aluminum Power Current Box.....	107-110
LED Grow Light Aluminum Heatsink.....	111-112
New Energy Vehicle Charging Pile Shell.....	113-114
Aluminum Controller Shell.....	115-118
Custom Series CNC Aluminum.....	119-120

Frameless Glass Railing Aluminum Profiles

Ready Mold Frameless Glass Railing Profiles	121-138
---------------------------------------------------	---------

T-Slot Structural Aluminum Profiles

In Stock T-Slot Structural Aluminum Profile	139-142
T-Slot Structural Aluminum Profile Accessory.....	143-144
Ready Mold T-Slot Structural Aluminum Profile	145-156

Zhonglian Official Websites.....	157-158
Contact and Office Address	159

THE DEVELOPMENT

COURSE OF ENTERPRISES

▶ 1993 Year

Foshan Nanhai Zhonglian Aluminum Profile Co., Ltd. was established.

▶ 2008 Year

Obtained the quality management system certification and the national industrial product production license.

▶ 2009 Year

Zhonglian obtained the honorary certificate of "China Famous Brand".

▶ 2010 Year

The company launched the "Yalian" high-end brand. In the same year, it obtained a series of certificates such as the Certificate of Adopting International Standard Product Marking.

▶ 2012 Year

Changed Name to Guangdong Zhonglian Aluminum Co., Ltd. Obtained the title of "Top Ten Key Enterprises" and "Guangdong Famous Trademark".

▶ 2014 Year

Obtained the title of "Guangdong Famous Brand Product". Create a sub-brand "Pailian"

▶ 2017 Year

Set up a branch factory for CNC processing aluminum profiles and create a sub-brand "Zhongchang Aluminum"

▶ 2021 Year

Entered the new modern office of the Ministry of International Trade Annual Export US \$20,000,000

▶ Feature



One-stop solutions

As your one-stop solution for both design, manufacturing, surface finishing and CNC service of your custom aluminum profile, save time and ensure quality, reducing the risk of production.

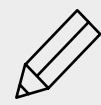

Unlimited aluminum design

We have 4 aluminum profile engineers with more than 20 years of experience and a number of senior designers, who can customize various aluminum profiles and improved drawing sizes for customers.



Very large dimensions

Compared with other aluminum profile factories, Zhonglian Factory can produce aluminum profiles in a wide range of sizes, especially the production of super-sized aluminum profiles over 300MM is beyond the reach of most suppliers.



Unparalleled manufacturability

The company has 600 tons to 5000 tons of advanced aluminium profile extrusion equipment, anodic oxidation lines, electrophoretic coating lines, powder spraying profile production line, wood grain production line, and a number of deep processing equipment.



Strict standards

The "Yalian" aluminium alloy profiles produced by the company strictly implement the national GB5237-2017 standard, and have passed the certification of ISO 9001 quality management system and ISO14001 environmental management system certification.

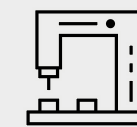

Comprehensive deep processing

Projects can be demanding, and we offer light fabrication services to help get your project complete. Our services include cutting to custom lengths, drilling or countersinking, deburring, punching, forming, bending, and assembly.



亚联铝材

YALIAN ALUMINUM

— Global Brand Since 1993

派联®

PAILIAN®

PAILIAN is one of the sub-brands of Zhonglian Aluminum (YALIAN) . Its main products are industrial aluminum profiles and architecture aluminum profiles, which are mainly sold in Europe and the Middle East.

Sub-Brand since 2014

中畅铝®

ZHONGCHANGLV®

ZHONGCHANGLV is one of the sub-brands of ZHONGLIAN Aluminum (YALIAN) . Its main products are CNC aluminum profiles, marine aluminum profiles and RV aluminum profiles, which are mainly sold in North and South America and Australia.

Sub-Brand since 2017



PAICHANG®

PAICHANG is one of the sub-brands of ZHONGLIAN Aluminum (YALIAN). Its main products are aluminum tubes and windows and doors aluminum profiles, furniture aluminum profiles, which are mainly sold in Asia, Africa and Southeast Asia.

Sub-Brand since 2021



 Enterprise Management team

Our business management team has more than 20 years of business management experience and international market experience, enabling our factories to quickly respond to customers' demanding production requirements, aiming to help them win more market shares

 International Trade team

We have an international trade team of more than 30 people and have rich experience in international trade. We are good at helping customers solve cross-border trade problems. We have served more than 70 countries and more than 1,000 overseas customers.

 Products R&D team

We have our own R&D team armed with an international vision and sophisticated R&D capabilities. More than ten national patents under its belt, the team excels in assimilating global advanced technologies and techniques into its own R&D expertise.



More than 20 years of experience in the aluminum profile industry, good at enterprise personnel management, established long-term strategic cooperation with more than 100 major overseas customers, and led the team to achieve sales of over 100 million US dollars.

With the spirit of "high quality, credibility, strict management and development" as its purpose, constantly forging ahead and reforming.

- CEO , IVY ZHENG // ZHONGLIAN



E-mail: 18@zl-alu.com



Tel: +86-13543617955



Wechat: [ivy139286](https://www.wechat.com/p/ivy139286)

**Jon**General Technical Adviser
20 Years experience

- ✉ E-Mail:13679856219@163.com
- ☎ TEL:+86-13679856219
- 👤 Wechat:13679856219

**Mr. Zheng**Industry Technical Elite
15 Years experience

- ✉ E-Mail:45113235@qq.com
- ☎ TEL:+86-15976626300
- 👤 Wechat:a45113235

**Champion**Industry Technical Elite
15 Years experience

- ✉ E-Mail:3350088490@qq.com
- ☎ TEL:+86-18825924517
- 👤 Wechat:18825924517

**Mr. Liu**Industry Technical Elite
15 Years experience

- ✉ E-Mail:
- ☎ TEL:
- 👤 Wechat:

**Ms. Wu**

Financial Director

- ✉ E-Mail:463397882@qq.com
- ☎ TEL:+86-18820857338
- 👤 Wechat:18820857338

**Ms. Pan**

Executive Director

- ✉ E-Mail:
- ☎ TEL:
- 👤 Wechat:

**Daisy**

Sales Executive

- ✉ E-Mail:
- ☎ TEL & Whatsapp:
- 👤 Wechat:

**Anna**

Sales Executive

- ✉ E-Mail:
- ☎ TEL & Whatsapp:
- 👤 Wechat:



Wendy
Sale Manager

- E-Mail:
- TEL & Whatsapp:
- Wechat:



Bella
Sales Executive

- E-Mail:
- TEL & Whatsapp:
- Wechat:



Cathleen
Sale Manager

- E-Mail:
- TEL & Whatsapp:
- Wechat:



Winnie
Sales Executive

- E-Mail:
- TEL & Whatsapp:
- Wechat:



Cherry
Sale Manager

- E-Mail:
- TEL & Whatsapp:
- Wechat:



Vicky
Sale Manager

- E-Mail:
- TEL & Whatsapp:
- Wechat:



Sandra
Sale Manager

- E-Mail:
- TEL & Whatsapp:
- Wechat:



Yetta
Sale Manager

- E-Mail:
- TEL & Whatsapp:
- Wechat:



Stephen
Sale Manager

- ✉ E-Mail:
- ☎ TEL & Whatsapp:
- 👤 Wechat:



Clay
Sale Manager

- ✉ E-Mail:
- ☎ TEL & Whatsapp:
- 👤 Wechat:



Daisy
Sale Manager

- ✉ E-Mail:
- ☎ TEL & Whatsapp:
- 👤 Wechat:



Chloe
Sale Manager

- ✉ E-Mail:
- ☎ TEL & Whatsapp:
- 👤 Wechat:



Rosa
Sale Manager

- ✉ E-Mail:
- ☎ TEL & Whatsapp:
- 👤 Wechat:



Kay
Sale Manager

- ✉ E-Mail:
- ☎ TEL & Whatsapp:+86-18825982190
- 👤 Wechat:



Flower
Sale Manager

- ✉ E-Mail:
- ☎ TEL & Whatsapp:
- 👤 Wechat:



Ms.He
Sale Manager

- ✉ E-Mail:
- ☎ TEL & Whatsapp:
- 👤 Wechat:



Production with quality and service.

At ZHONGLIAN, thanks to our high vertical integration, we control all production processes to provide products that stand out for their quality and impeccable technical characteristics. Our industrial facilities include:

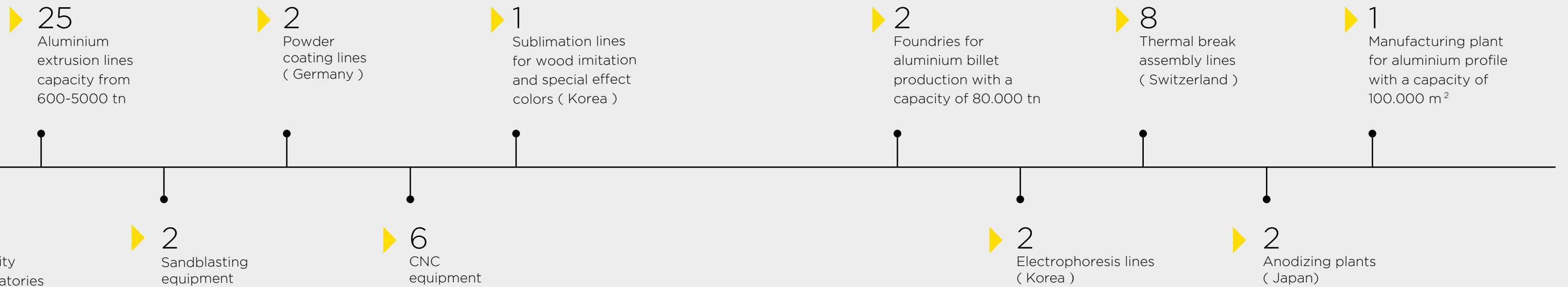

Create spectacular building, using the complete ZHONGLIAN technology.

From aluminium rod casting, die development, profile extrusion, uniform sandblasting, anodic oxidation, single and double salt coloring, electrophoretic coating, multi-color powder spraying, wood grain simulation, energy saving and heat-insulating aluminium profiles, and even precision testing, ZHONGLIAN has adopted more advanced international technology, high degree of automation, so that the products.

It is a broad set of aluminium solutions, customised at will, for the implementation of multiple construction designs.



Advantages of ZHONGLIAN technical

- / Advanced equipment and flawless operation for exceptional anodizing surface treatment effect
- / CNC products will conduct sample testing and send samples and testing reports to customers for confirmation.
- / Our CNC centers will allow you to produce highly accurate and quality parts to meet even your most stringent requirements.
- / As your one-stop solution for both manufacturing and surface finishing of your custom CNC machined parts, reducing the risk of production.
- / CNC turning machines are able to provide low cost parts for simple cylindrical geometries.

01

▶ Anodizing Production line

02

▶ Sandblasting Production line

03

▶ 3,000 tn Extrusion line

04

▶ Cutting line

05

▶ 100,000 Workshop



➤ Focus on R&D and production of aluminum profiles for 30 years



▲ Casting



▲ Extrusion



▲ Anodized



▲ Wood Grain



▲ Powder Coating



▲ Sand Blasted



▲ Brushed

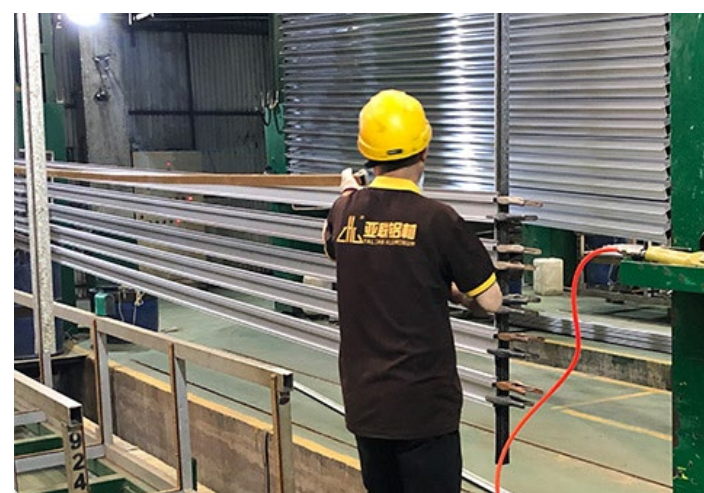

▲ Electrophoresis



▲ CNC Service

Advanced equipment, superb technology

ZHONGLIAN knows that good products are inseparable from good production equipment. Therefore, the company continues to spend huge sums of money to introduce various advanced process equipment to create excellent quality.

The ZHONGLIAN team has a group of senior engineers and technicians who are good at innovation and strict quality. They use superb technology to engrave the quality commitment of ZHONGLIAN Aluminum to customers!



ZHONGLIAN CUSTOM SERVICE

Custom Design & Custom Dies

We have more than 30000 moulds in stock .If our Aluminum profiles are not suitable for you, you could provide us your samples or technical drawings, we can extruded according to your designs.

ZHONGLIAN aluminium aims to offer the best prices, best quality, and best lead times in the aluminum extrusion industry. With an average of 6 to 8 week turnaround on brand new shapes and 4 weeks for special order of stocked dies, ZHONGLIAN is a step ahead of the competition.

Needing somethingfaster? Our customer service team understands the importance of your project and we do our best to meet or exceed any expectations our customers have.

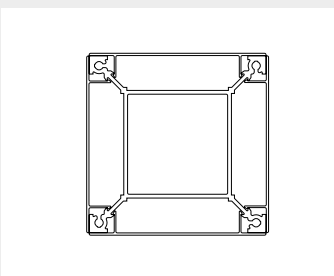

▶ Drawing



▶ Sample

Provide Samples or Drawings

- ▶ If your project demands a custom aluminum extrusion, we will help you engineer and design the perfect die solution for your requirements.
- ▶ ZHONGLIAN aluminiumis committed to providing two things, the highest quality customer service along with the highest quality custom, OEM and stock aluminum extrusions.
- ▶ Whether your project requires a standard shape, or a custom designed die, we're capable of delivering high quality, functional extrusions that meet your tight schedule and budget.

CUSTOM Special-Shape Profiles 3Step.

Step 1:

Export your design to a CAD file format

The file formats predominantly used in CNC machining are STEP and IGES. These formats are open-source, standardized and can be used across platforms.

For best results:

Export your designs directly from your native CAD software into the STEP file format.



Step 2:

Prepare a technical drawing

A technical drawing is not always required for machining parts with CNC. Yet it is recommended to include one in your order as it has information that is not presented in a STEP file.

Step 3:

Get an instant quote & start manufacturing



Send Your CAD files

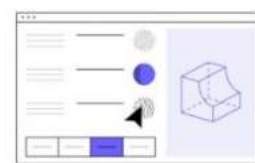

Specify your requirements



Get an instant quote

A technical drawing is required in the following:

- When your design contain threads
- When any tolerances are specified
- When certain surfaces need a different finishing

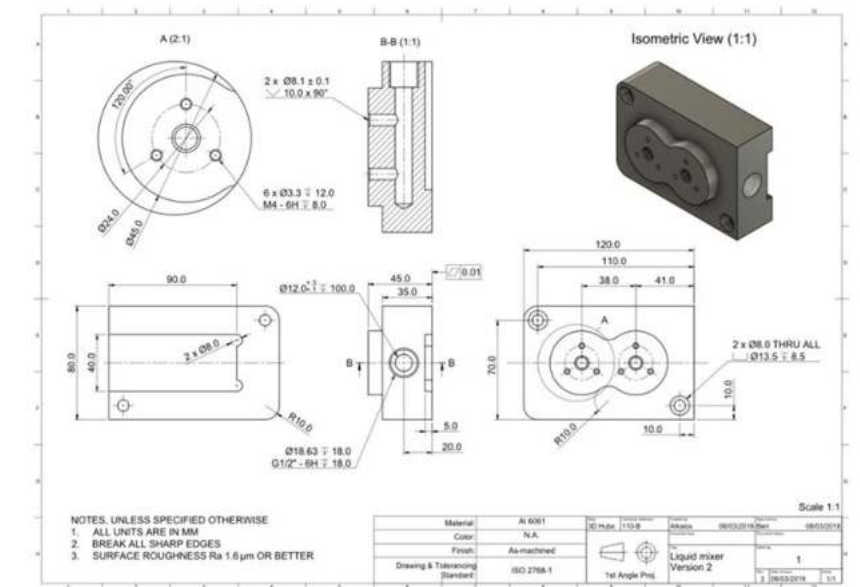



When ZHONGLIAN takes on a project, your goals become ours. Whether you require custom extrusions or standard aluminum profiles, our experience, and personalized customer service as one of the top aluminum extrusion supply companies, will keep you coming back.

LIGHT FABRICATION

Projects can be demanding, and we offer light fabrication services to help get your project complete. Our services include cutting to custom lengths, drilling or countersinking, deburring, punching, forming, bending, and assembly.

- / Cutting to Length
- / Countersinking
- / Assembly
- / Punching
- / Welding
- / Drilling
- / Small Piece Anodized
- / Mitering Corners
- / Deburring
- / Forming
- / Bending
- / Turning

Your custom extrusion isn't complete until it's ready for installation. ZHONGLIAN custom drilling, punching, and countersinking services allow you to choose your hole size, pattern, and starting location on your custom aluminum extrusion for faster on-the-job application. After cutting, ZHONGLIAN also offers deburring services to create and smooth cut clean edges. Finally, finish off the look of your aluminum extrusion with ZHONGLIAN'S mechanical brushing and polishing offerings or the specialty anodizing and powder coating finishes.

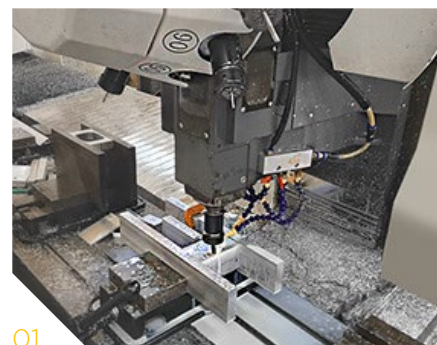

01



02



03



04



05

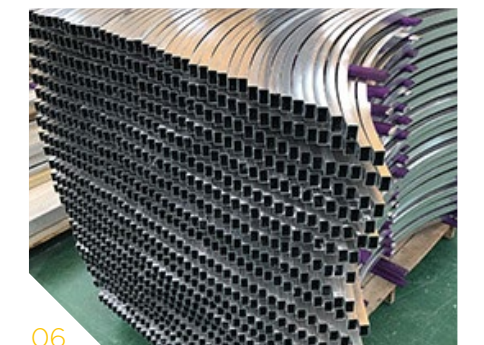

06

As a supplier of aluminum extrusion profiles, ZHONGLIAN provides access to a nationwide network of manufacturers. ZHONGLIAN pools multiple resources to assure we can meet your requirements, delivering the right products, at the right time, and at the right price.

▶ Industrial Aluminium profiles

- / LED Aluminium Profile ■
- / Heat Sink Aluminum Profile ■■
- / Car & Truck Aluminium Profile ■
- / U Channel Aluminum Profile ■■
- / L Angle Aluminium Profile ■■■
- / T Track Aluminum Profile ■
- / T Shape Aluminum Profile ■
- / T Slot Aluminum Profile ■■■
- / H Beam Aluminum Profile ■■
- / E Shape Aluminum Profile ■
- / Z Shape Aluminum Profile ■
- / Aluminum Plate & Bar ■
- / Aluminium Solar Panel Frame ■■
- / Advertising Aluminum Profile ■■
- / Anti-Skid and Dirt Protection Systems ■
- / Cable Channels and Light Boxes Profile ■
- / Electrical Aluminium Profile ■
- / Exhibition Equipment Aluminum Profile ■
- / Electrical Purposes Aluminum Profile ■
- / Edging and Docking Aluminum Profile ■
- / Hatches Aluminum profile ■
- / Medical Equipment Aluminum Profile
- / Mortgages Aluminum Profile ■
- / Mosquito Nets Aluminum Profile ■
- / Road Fencing Systems Aluminum Profile ■
- / Whiteboard Frame Profile ■

▶ Architectural Aluminium Profiles

- / Window and Door Aluminum Profile ■■
- / Air Conditioning Aluminum Profile ■
- / Ventilation Aluminum Profile ■
- / Curtain Wall Aluminum Profile ■■■
- / Clean Room Aluminum Profile ■■
- / Decking Aluminum Profile ■
- / Drainage System Aluminum Profile ■
- / Elevators Aluminum Profile ■■
- / Fence Aluminum Profile ■■
- / Formwork Aluminum Profile ■
- / Garden Aluminium Profile ■■
- / Greenhouse Aluminum Profile ■
- / Gypsum Vinyl Panels Profile ■
- / Handrail Aluminum Profile ■■
- / Louver Aluminum Profile ■■
- / Office Partition Aluminium Profile ■■
- / Pergola Aluminum Profile ■
- / Shutter Aluminum Profile ■■
- / Sun Room Aluminum Profile ■
- / Stretch Ceiling Aluminum Profile ■
- / Thresholds Aluminum Profile ■
- / Ventilated Facades Aluminum Profile ■

▶ RV, Motorhomes, Trailers Profiles

- / Slide Track Channel Profile ■
- / Roof Edging Aluminum Profile ■
- / Rub Rail Aluminum Profile ■

▶ Machined & CNC Aluminium Profiles

- / 5G Signal Pole ■■
- / CNC Aviation Aluminum Gantry ■
- / CNC Ashtray ■
- / CNC Alipay Stand ■■
- / CNC Charging Pile ■■
- / CNC Door Handle ■■
- / CNC Equipment shell ■
- / CNC Glass Clamp ■■■
- / CNC Hingle ■
- / CNC Heater ■
- / CNC Heat Sink ■■
- / CNC Pipe ■■
- / CNC Housing Part ■
- / CNC Machine Part / Accessory ■
- / CNC Small Part Wood Grain ■■
- / CNC Street Light ■■
- / Welding, Bending, Drilling ■
- / Other CNC Products ■

▶ Furniture Aluminium Profiles

- / Fish Tank Aluminum Profile ■
- / Kitchen Aluminium profile ■■■
- / Photo Frame Aluminum Profile ■■
- / Shower Room Aluminum Profile ■■
- / Wardrobe Aluminium profile ■■

▶ Aluminum Tube & Pipe

- / Aluminum Tube Closure ■■
- / Rectangular Tube ■■■
- / Square Tube ■■■
- / Round Pipe ■■■
- / Half Round Pipe ■■
- / Oval Pipe ■■
- / Triangular Tube ■■
- / Custom Aluminum Tube ■

▶ Boat / Marine Aluminium Profiles

- / Boat Masts Aluminum Profile ■
- / Boat Keel Marine Chine ■
- / Boat Fendering Profile ■
- / Boat Tee Aluminum Porfile ■
- / Boat Lift Profile ■
- / Boat Trims Profile ■
- / Boat Trailers Profile ■
- / Boat Deck Houses Profile ■
- / Boat Windscreen Frames Profile ■
- / Boat Gratings Profile ■
- / Boat Ladders Profile ■
- / Boat Handrails Profile ■
- / Custom Boat Profile ■



Custom Surface Treatment, Finishes

ZHONGLIAN offers a variety of aluminum finishing services and options allowing you to perfectly customize your project. Aluminum finishes can give your extrusions a chic, professional look not only improving the aesthetics, but also the performance.



GB Matt Anodized



Anodized

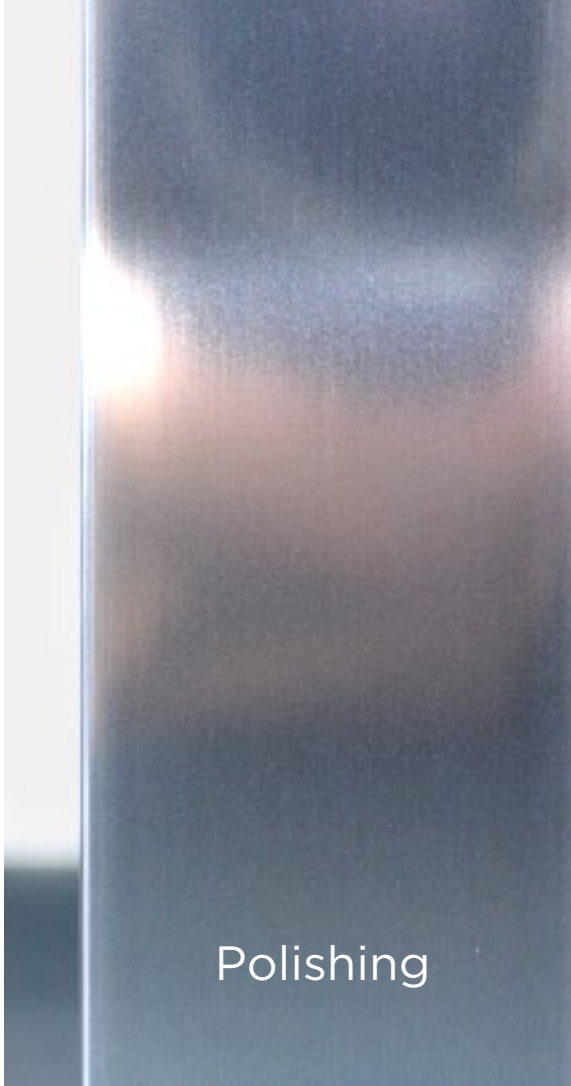

Polishing



Mill Finish



Brushed



Powder Coating



Wood Grain



Anodized Sandblasting



Electrophoresis



POWDER COAT COLOURS

Inspired by natural beauty, ZHONGLIAN offers a rich colour range designed to create the perfect colour scheme.



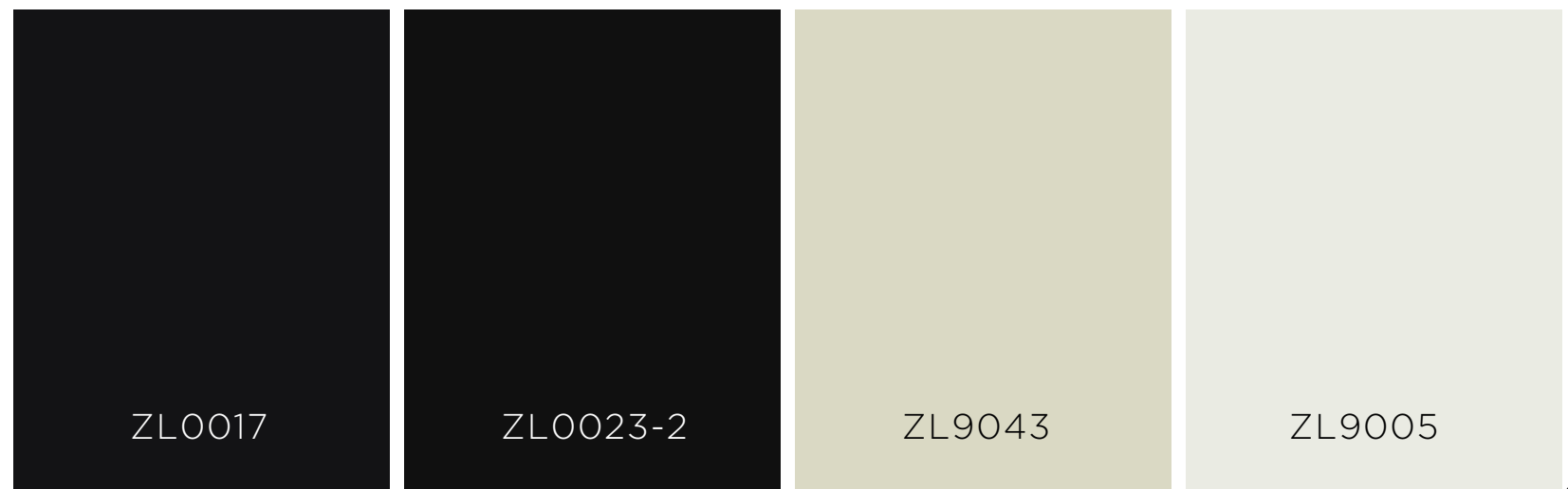



Please note:
 Due to the factors of the lighting and the resolution of the electronic device display, there will be a color difference between the picture and the real object. These colours are a guide only. To ensure best accuracy, test your colour choice at home by requesting a free sample.



POWDER COAT COLOURS

Our wood grain colour range is textured and reproduced from handpicked natural timbers.

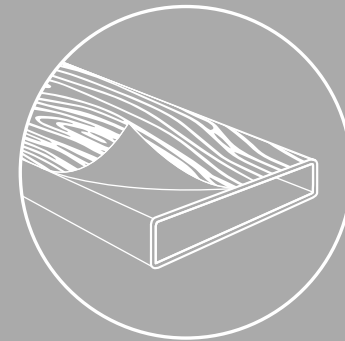

ZHONGLIAN combines the natural beauty and timeless appeal of wood with the capabilities of aluminium. Our specialty powder coating process produces natural wood grain colours that are textured to feel like real wood. All of our aluminium systems and products are available in our extensive range of powder coated and wood grain colours.



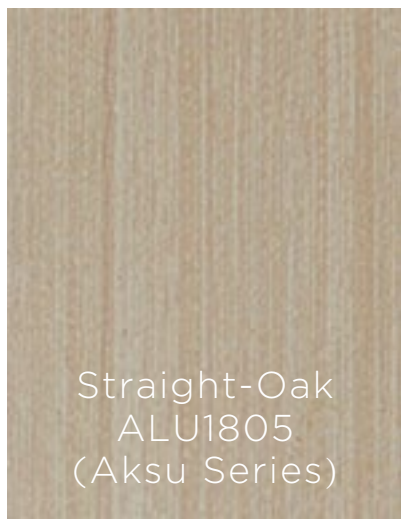

Straight-Oak
ALU1805
(Aksu Series)



Pinus-Koraiensis
ALU1865
(Aksu Series)

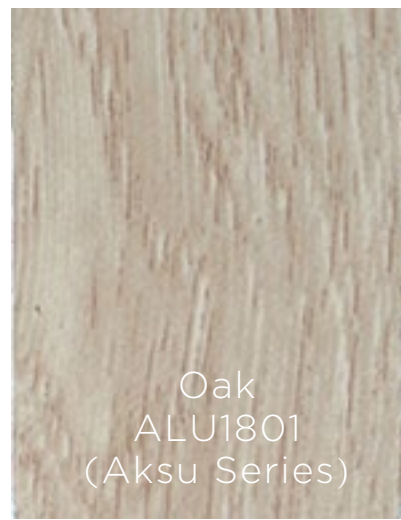

Oak
ALU1801
(Aksu Series)

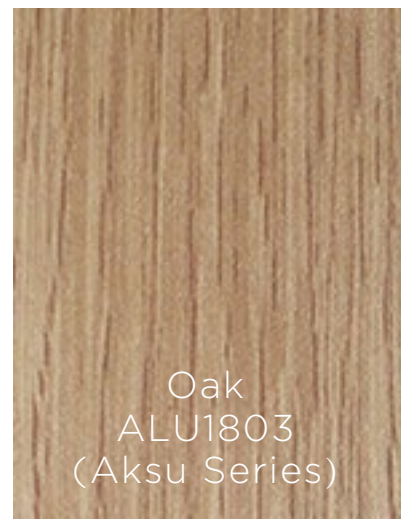

Oak
ALU1803
(Aksu Series)

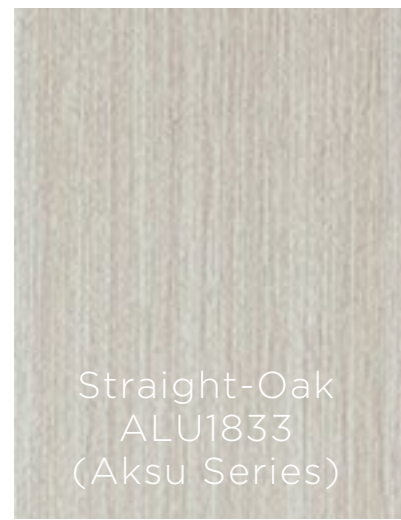

Straight-Oak
ALU1833
(Aksu Series)

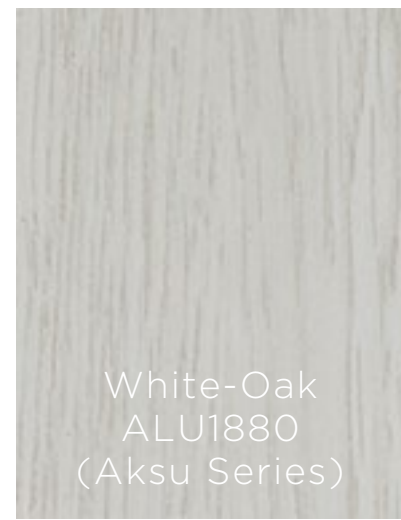

White-Oak
ALU1880
(Aksu Series)

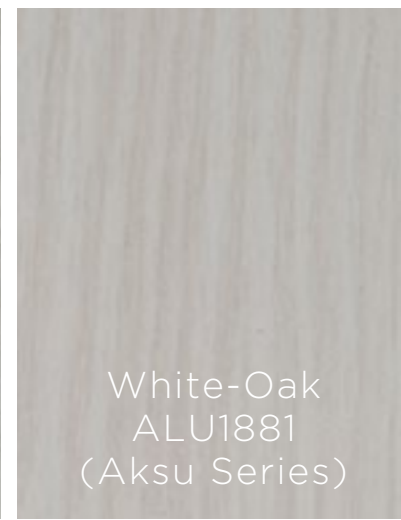

White-Oak
ALU1881
(Aksu Series)



3D-Pine
ALU1882
(Aksu Series)



Bamboo-Pattern
ALU1808
(Aksu Series)

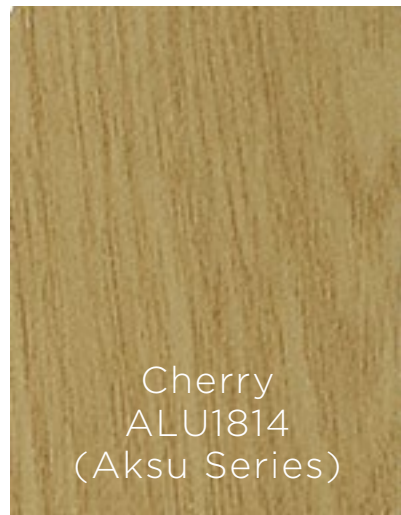

Cherry
ALU1814
(Aksu Series)



Straight-Oak
ALU1811
(Aksu Series)

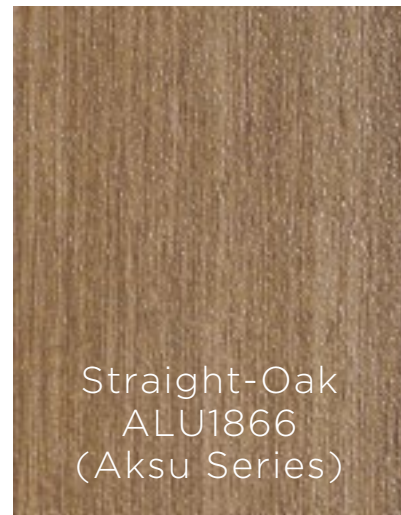

Straight-Oak
ALU1866
(Aksu Series)

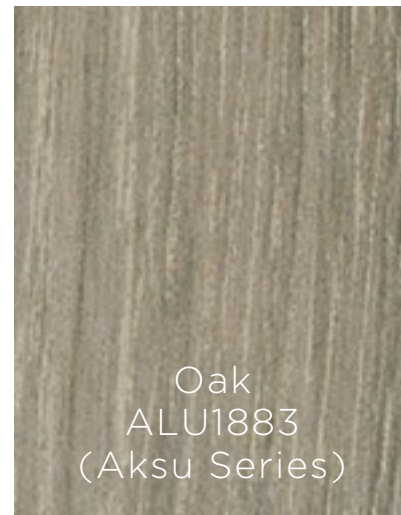

Oak
ALU1883
(Aksu Series)

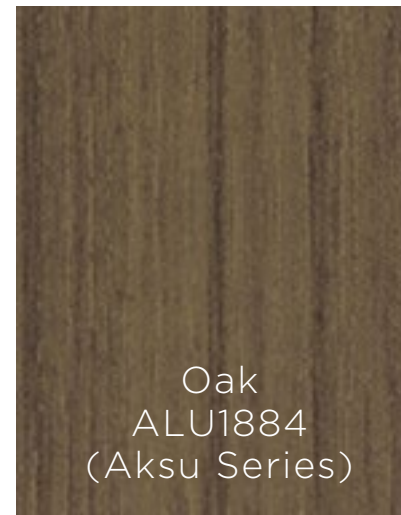

Oak
ALU1884
(Aksu Series)

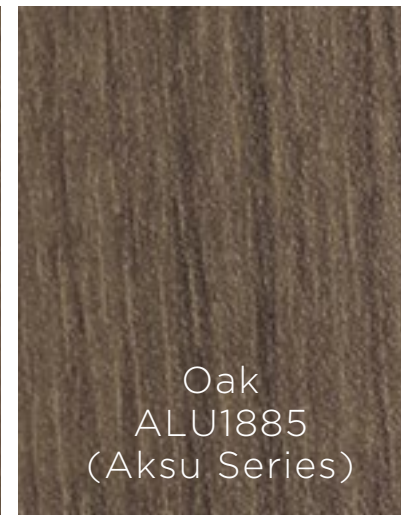

Oak
ALU1885
(Aksu Series)

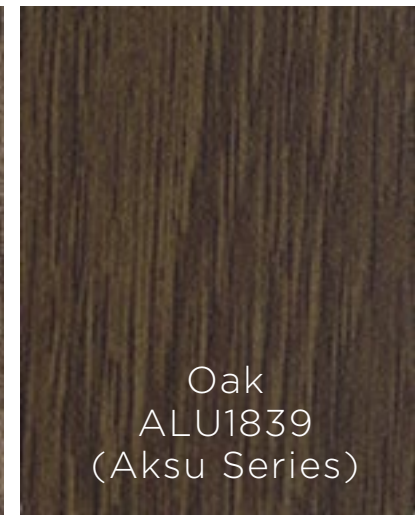

Oak
ALU1839
(Aksu Series)



Pine
ALU1870
(Aksu Series)

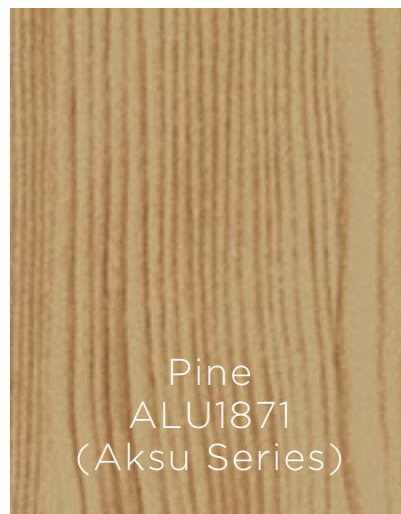

Pine
ALU1871
(Aksu Series)



3D-Pine
ALU1872
(Aksu Series)

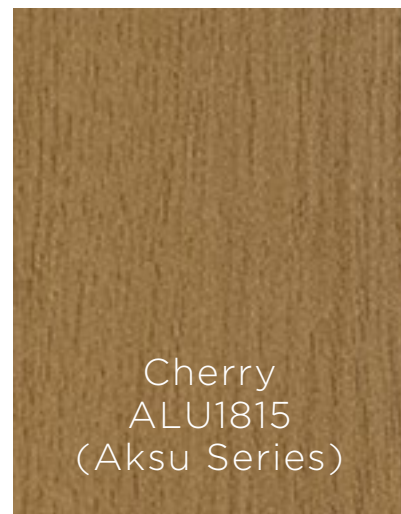

Cherry
ALU1815
(Aksu Series)

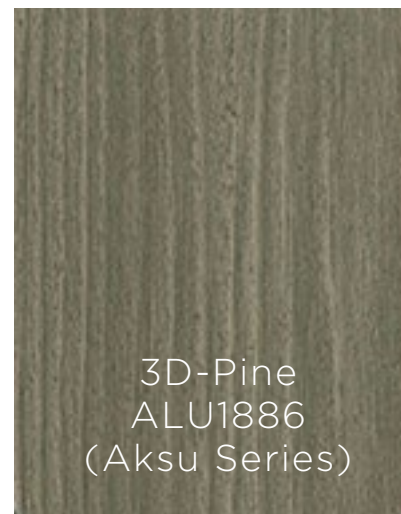

3D-Pine
ALU1886
(Aksu Series)



Oak
ALU1887
(Aksu Series)

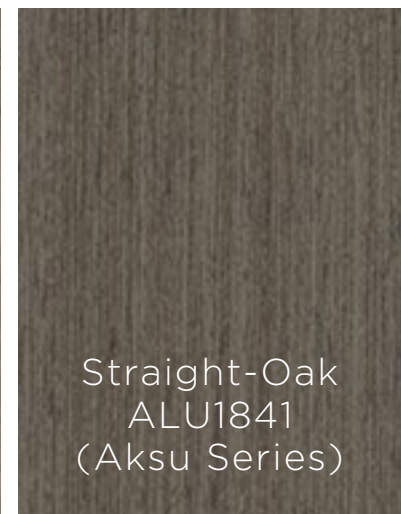

Straight-Oak
ALU1841
(Aksu Series)



Straight-Oak
ALU1836
(Aksu Series)

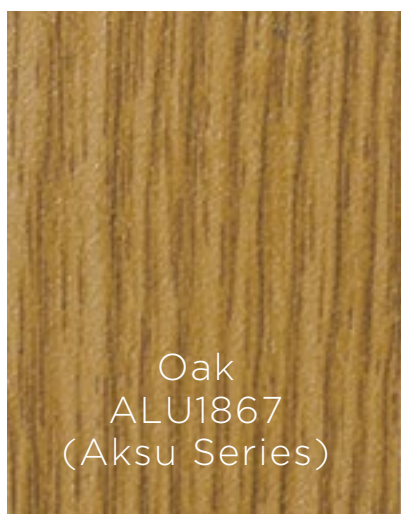

Oak
ALU1867
(Aksu Series)



Pinus-Koraiensis
ALU1868
(Aksu Series)

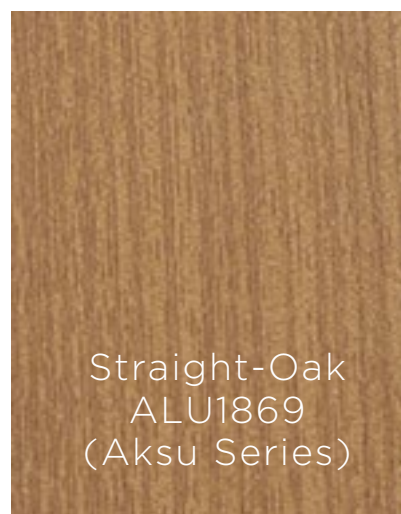

Straight-Oak
ALU1869
(Aksu Series)

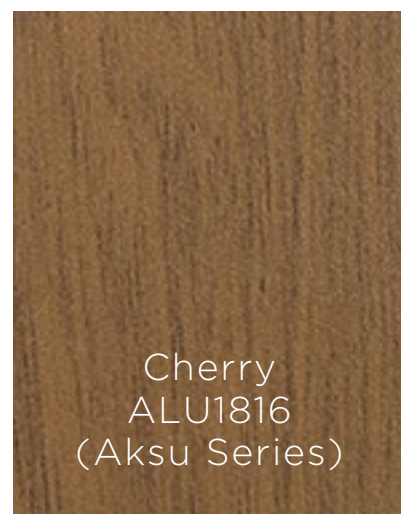

Cherry
ALU1816
(Aksu Series)



Straight-Oak
ALU1842
(Aksu Series)



Oak
ALU1843
(Aksu Series)



Grey-Oak
ALU1845
(Aksu Series)



Old-Oak
ALU1846
(Aksu Series)



Walnut
ALU1873
(Aksu Series)

Walnut
ALU1874
(Aksu Series)

Walnut
ALU1819
(Aksu Series)

Walnut
ALU1820
(Aksu Series)



Cherry
ALU1826
(Aksu Series)

3D-Pine
ALU1877
(Aksu Series)

Acidwood
ALU1827
(Aksu Series)

Red-Walnut
ALU1878
(Aksu Series)

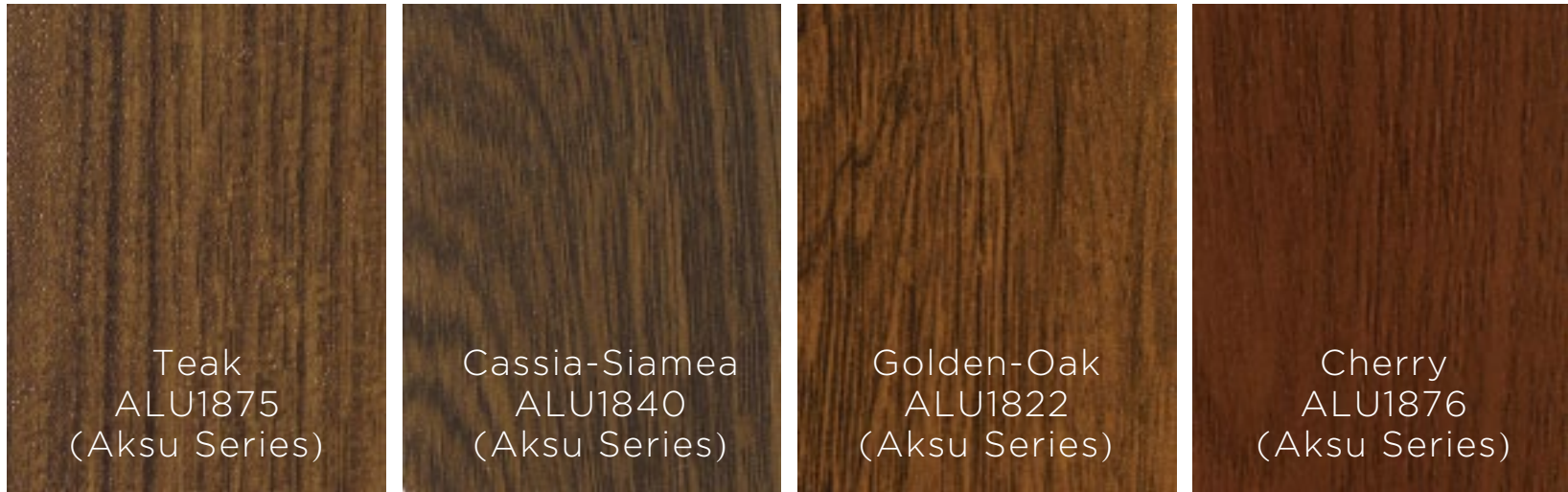

Teak
ALU1875
(Aksu Series)

Cassia-Siamea
ALU1840
(Aksu Series)

Golden-Oak
ALU1822
(Aksu Series)

Cherry
ALU1876
(Aksu Series)



Teak
ALU1829
(Aksu Series)

Teak
ALU1831
(Aksu Series)

Ancient-Wood
ALU1879
(Aksu Series)

Old-Oak
ALU1832
(Aksu Series)

15 YEAR WARRANTY Aksu Specialty Coatings

Ensuring a high standard in performance.

Quality and performance is paramount to ZHONGLIAN, so we have teamed up with leading powder coating specialists to create a unique powder that ensures our products will look great for longer.

The ZHONGLIAN range of Aksu Wood Grain products are supported by a 15 year performance warranty on the powder coating.

*Warranty applies only to aluminium when coated by an Aksu Wood Grain. Terms and conditions apply.

Aksu wood grain series MOQ is 5 tons, ordinary wood grain is 2 tons

Contact your ZHONGLIAN representative for further details.





ZLW8201-9

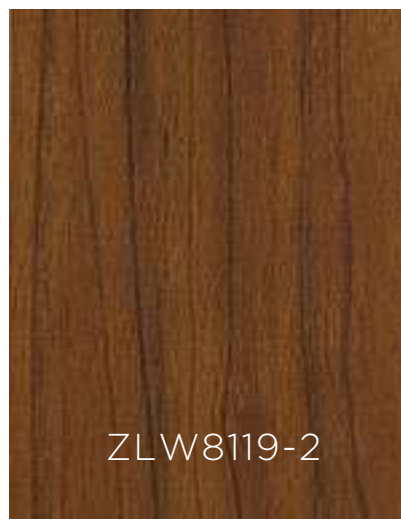

ZLW8119-2

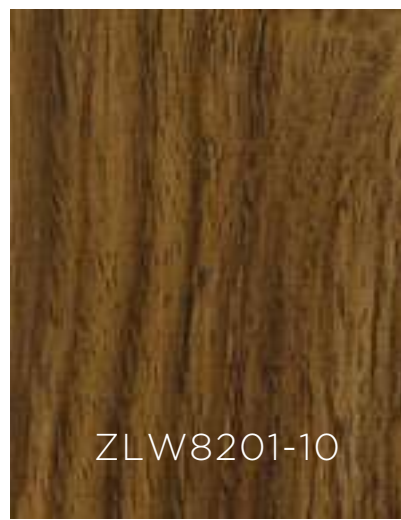

ZLW8201-10



ZLW8201-4

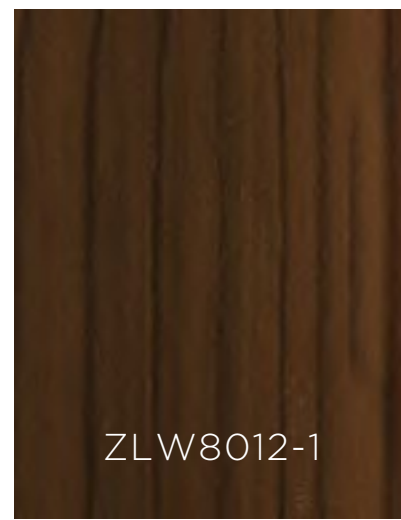

ZLW8012-1



ZLW8007
(2177A-23)

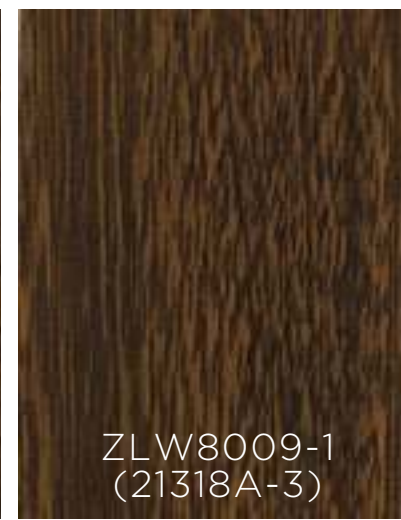

ZLW8009-1
(21318A-3)



ZLW9089-2
(2068-72)

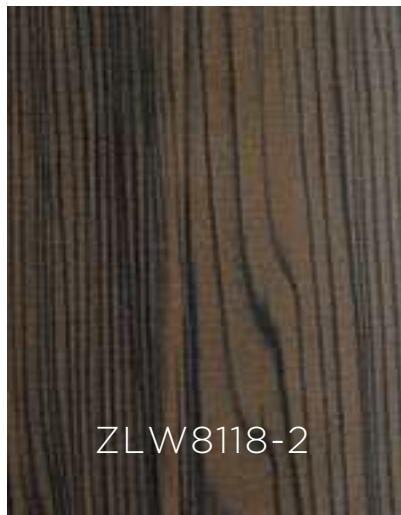

ZLW8118-2



ZLW8201-3



SKW8155-2

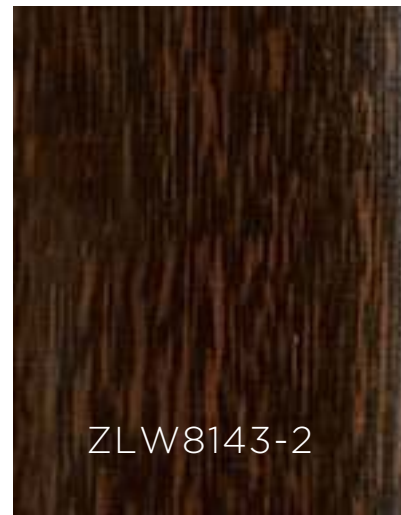

ZLW8143-2



ZLW8015

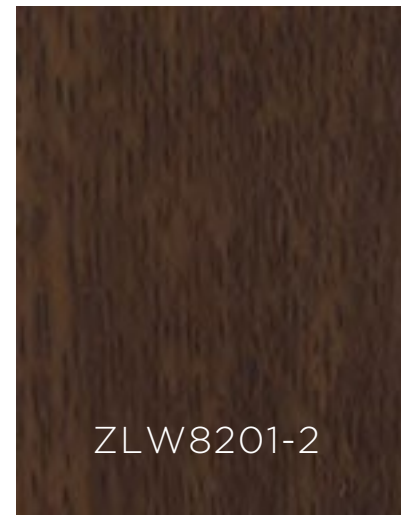

ZLW8201-2



ZLW8201-7

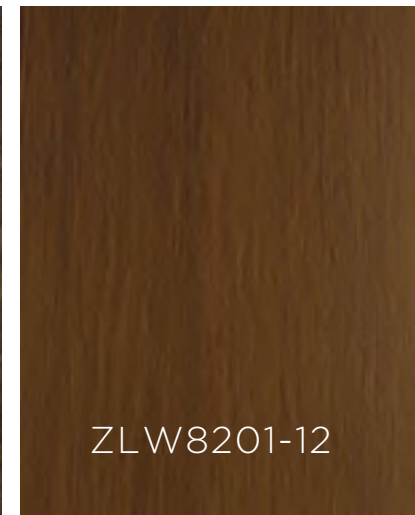

ZLW8201-12



ZLW8201-5

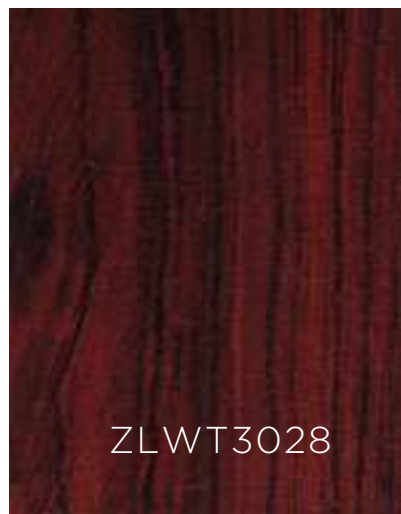

ZLWT3028



ZLW8201-14

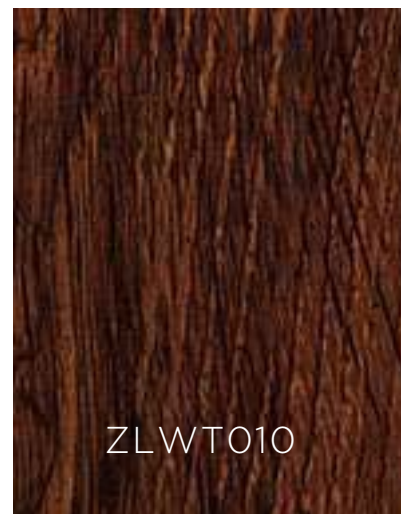

ZLWT010

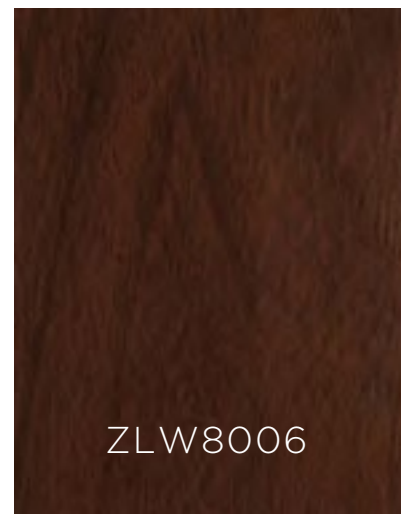

ZLW8006



ZLW8001
(2318A-3)

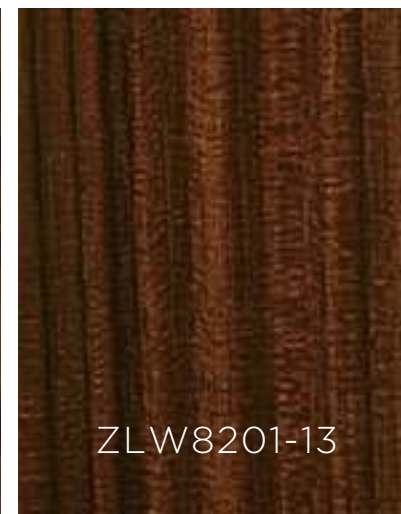

ZLW8201-13



ZLW7002



ZLWT004
(2352A)

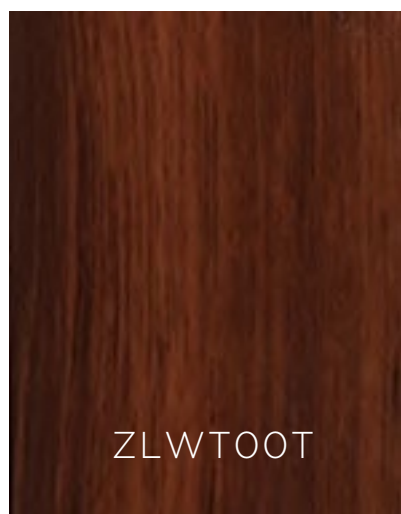

ZLWT00T



ZLW8201-8

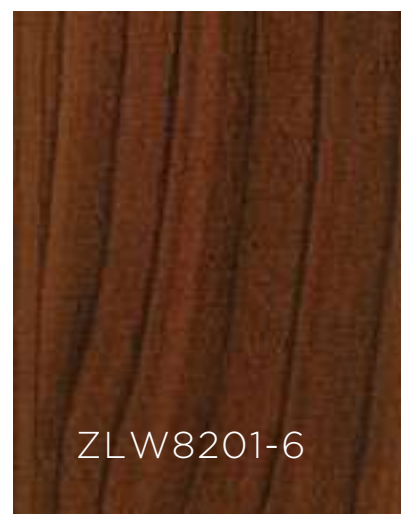

ZLW8201-6

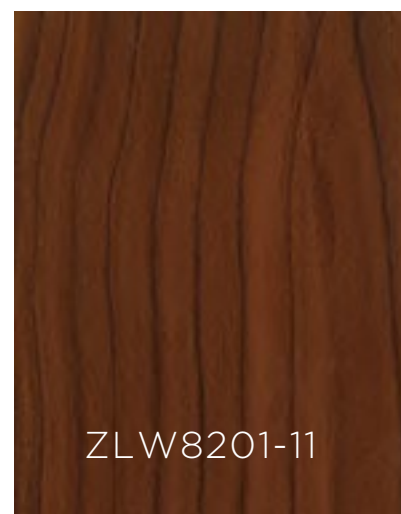

ZLW8201-11

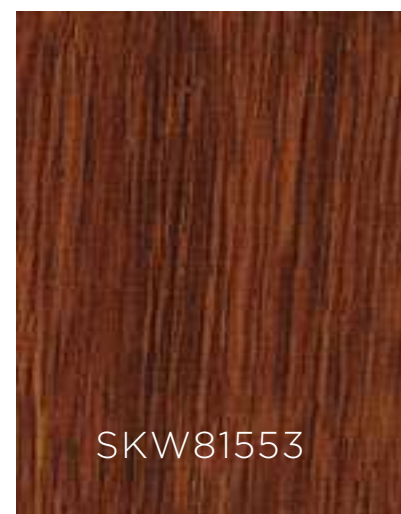

SKW81553

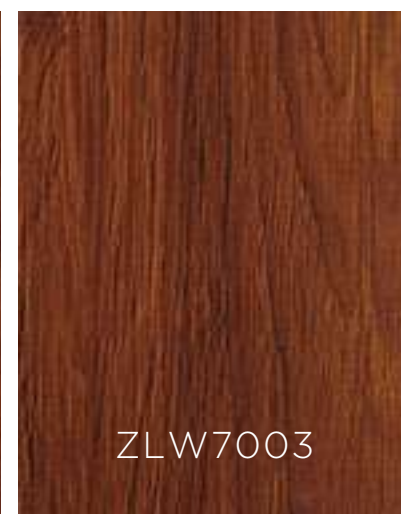

ZLW7003

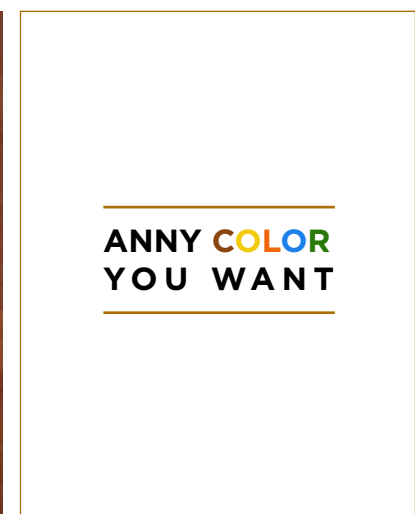

ANNY COLOR
YOU WANT



OTHER STANDARD FINISHES

ZHONGLIAN aluminum finishes come in several standard finishes such as anodized finishes to help create the exact look you need.

➤ STANDARD GB MATT ANODIZED FINISHES

Aluminum are usually exposed to various corrosive conditions (weather, coastal areas, etc.), thus, ZHONGLIAN, as a pioneering company, adopts the special surface treatment of pre-anodizing and noticeably reduces “filiform” corrosion.

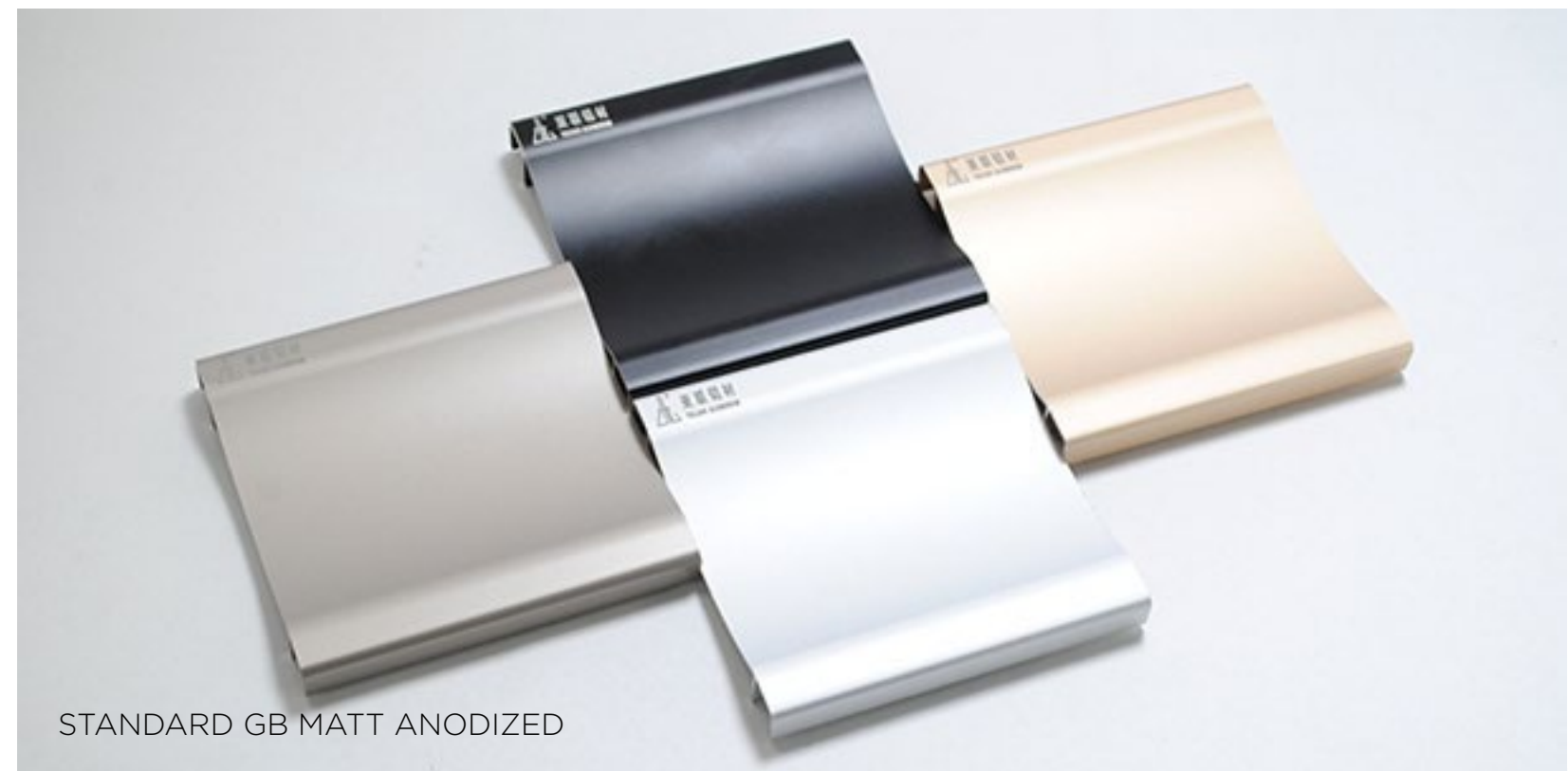

STANDARD BRUSHED FINISHES

Combine brushed with unlimited colors, creating long lasting architectural solutions of unparalleled style and quality.

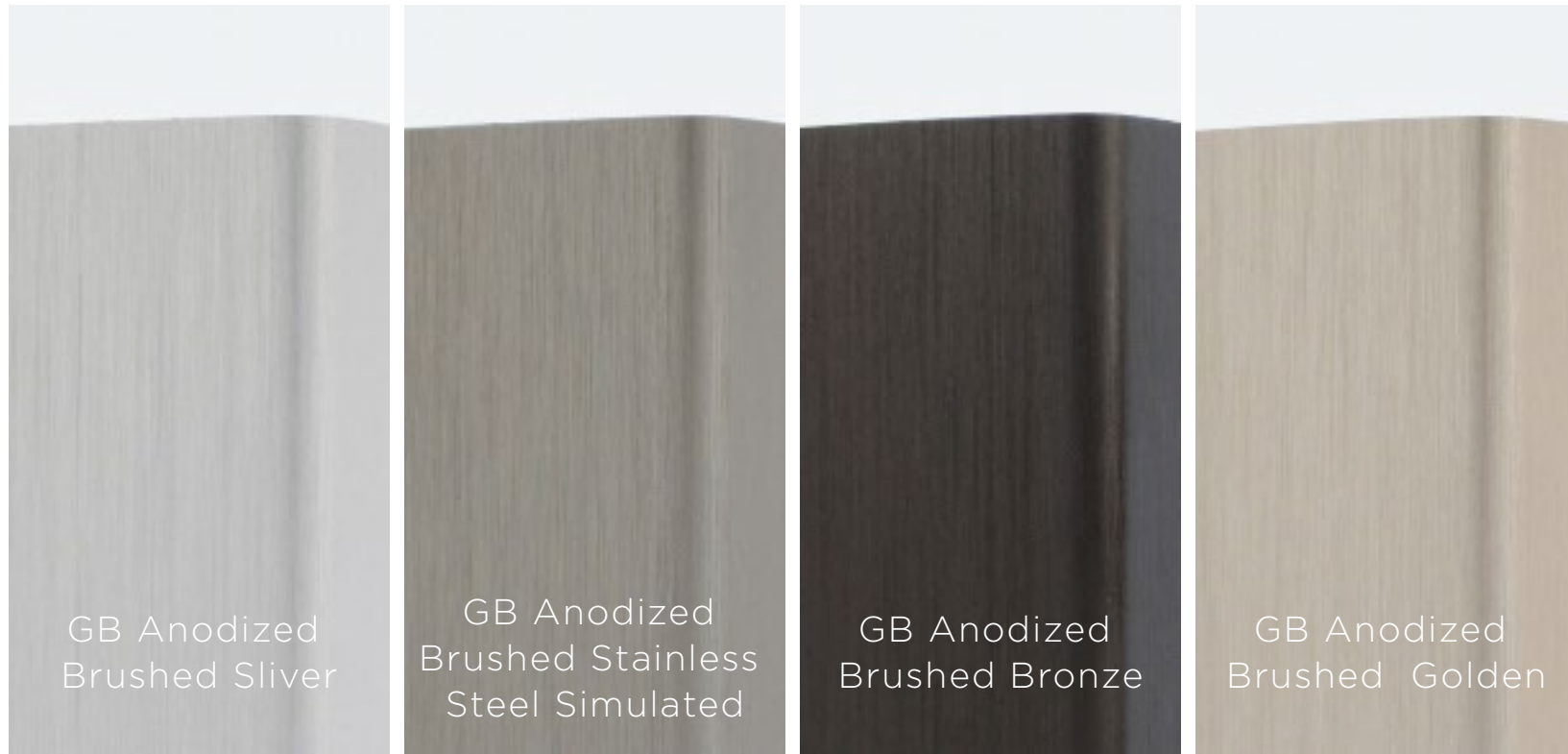

GB Anodized
Brushed Sliver

GB Anodized
Brushed Stainless
Steel Simulated

GB Anodized
Brushed Bronze

GB Anodized
Brushed Golden

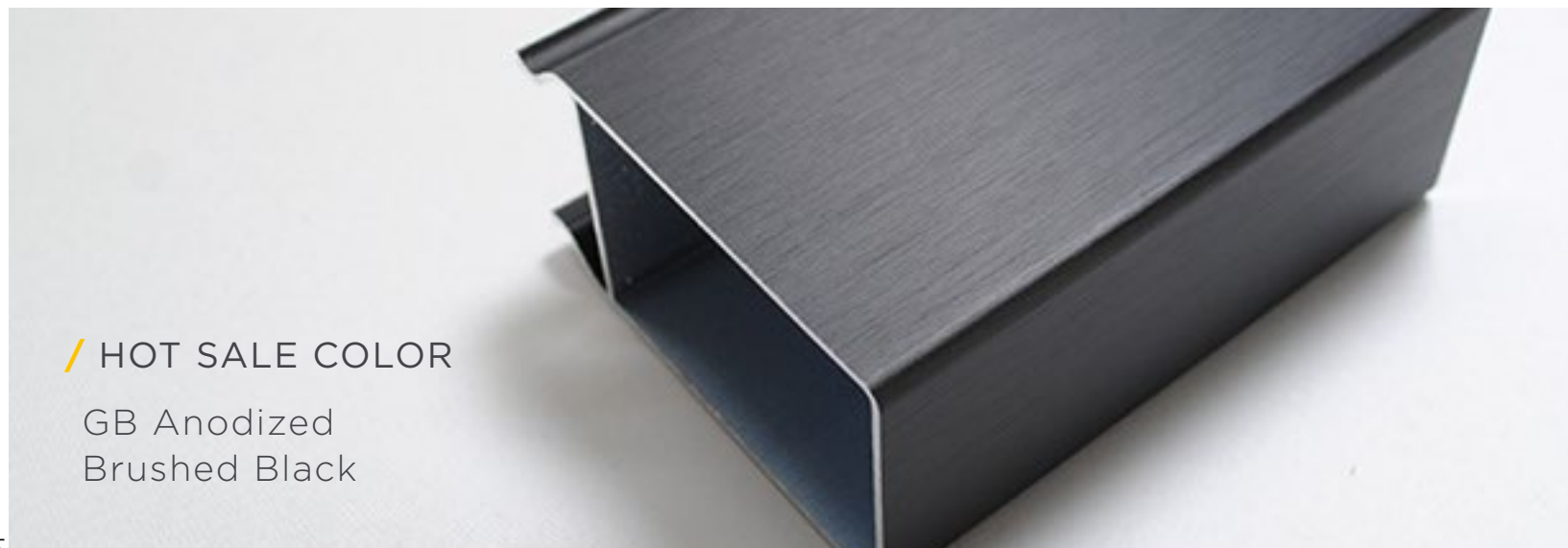

HOT SALE COLOR

GB Anodized
Brushed Black



STANDARD EXTINCTION BRUSHED FINISHES

Products of high transparency and full shielding rate is high, has a special luster and transparency, with a high degree after painting three-dimensional effect; good leveling, strong sense of the film, the film slippery feel good. And high hardness, when the temperature is 180°C Baking 30min, hardness can reach 4-5H, wear resistance and long service life. "Extinction Electric Wing" surface texture and delicate, non-stick oil, not water, attached to the surface of the dust and stains just gently A touch of light can restore the original and appearance.



Extinction
Brushed
Golden

Extinction
Brushed
Sliver

Extinction
Brushed
Black

Extinction
Brushed
Gray

STANDARD SHINNY BRUSHED FINISHES

A very popular style in Central Asia, especially beautiful, mostly used for furniture aluminum profiles

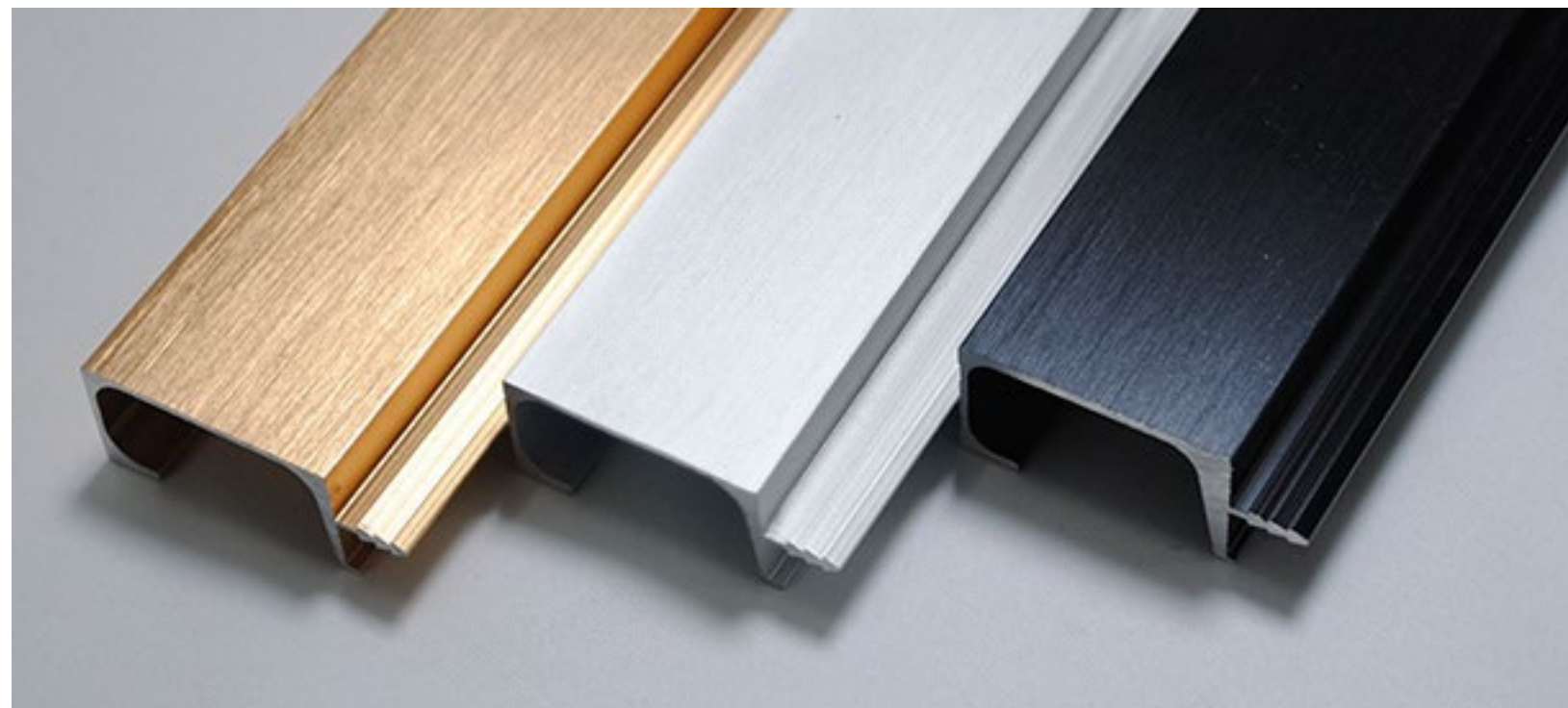

STANDARD POLISHING FINISHES

ZHONGLIAN Polising generally make 2-4 film thicknesses, the brightness can reach more than 500 degrees, and it can pass the 24-hour acid salt spray test.

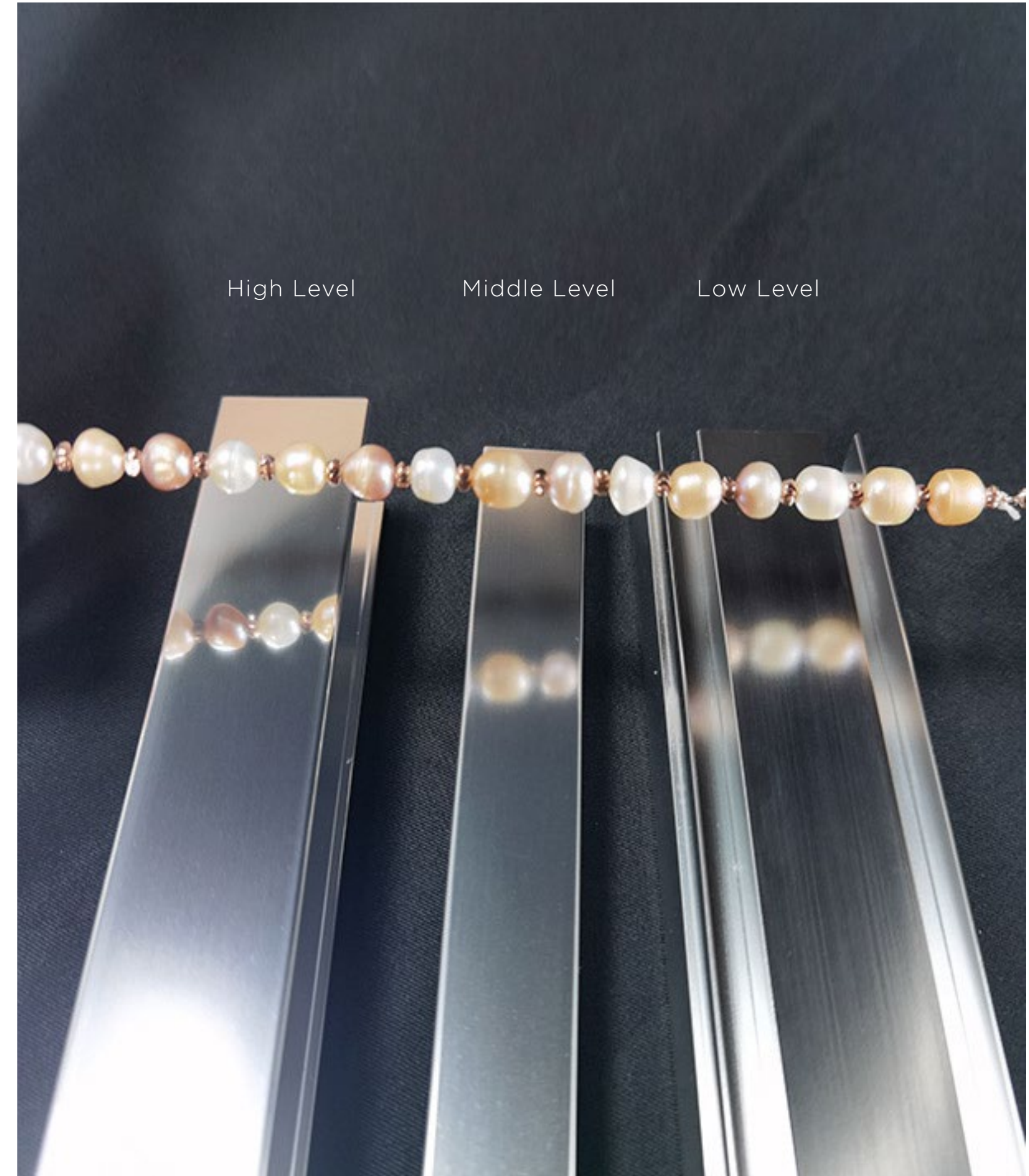

GERMAN HIGH-GRADE FINISHES

High-grade, precise sawing, no limit on length. (Depending on the situation); The surface requirements are extremely high, and there is no flaw at all. If 5% are not qualified, they can all be returned and re-extruded. Suitable for Europe, America, Germany and high consumption countries and regions.



German Series
Brushed Silver



German Series
Brushed Golden

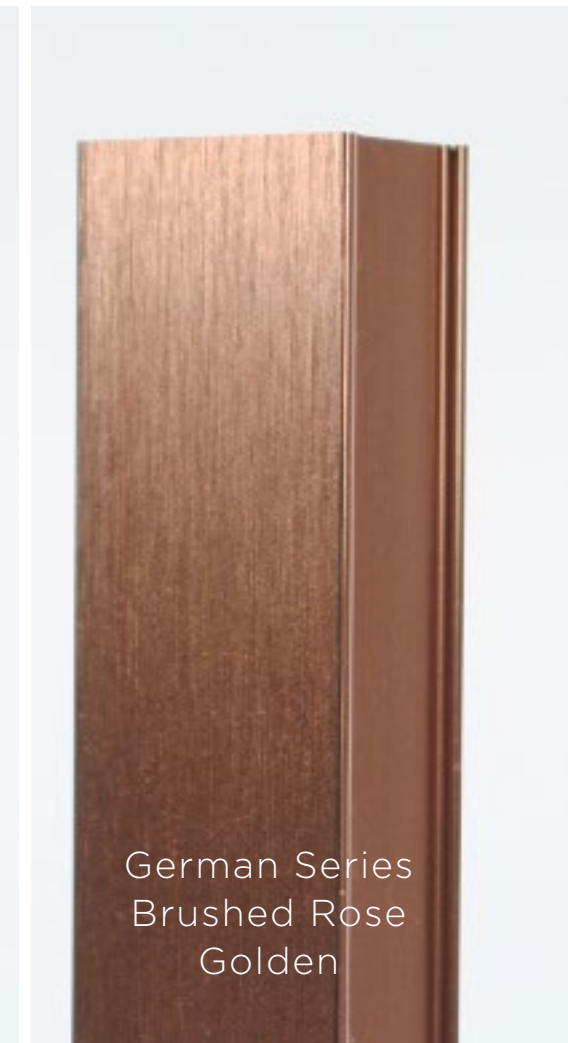

German Series
Brushed Rose
Golden



German Series
Anodized Black



German Series
Anodized Silver



German Series
Anodized Polished
Black

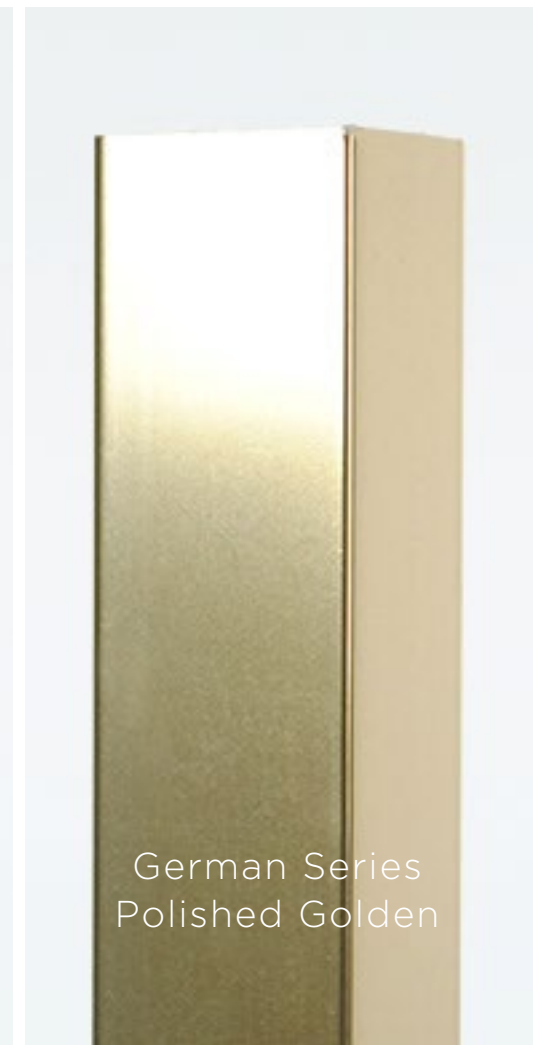

German Series
Polished Golden



German Series
Polished Rose
Golden

HONOR & CERTIFICATE

Honor is only the starting point, innovation never stops.
ZHONGLIAN adhere to the Road of Innovative Quality

- ▶ Business License - 50 Million Registered Capital
- ▶ Environmental Management System Certificate
/ GB/T 24001-2016/ISO 14001:2015
/ GB/T 19001-2016/ISO 9001:2015
- ▶ CE Certificate of Compliance
/ No. 3N211215.GZACO88 (Aluminum Alloy Profile)
Model: 6063-T5, 6063-T6, 6061-T6, 6061-T5, 6082-T5, 6082-T6, 6463-T5, 6463-T6, 6005-T5, 6005-T6, 1060, 3003, 6005A
- ▶ SGS Certificate of Compliance
/ No.CANML1903031301 (6063 Aluminium Profile)
/ No.CANML1903031303 (6063 Aluminium Profile of Anodized Shing Black)
/ No.CANML1903031305 (6061 Aluminium Profile)
/ No.CANML1810594901 (6063 T5 Aluminium Profile)
- ▶ ROHS Certificate of Compliance
/ No: SHAM20210301352 (6063-T5 Anodized Aluminum Alloy Profiles)
/ No: SHAM20210301353 (Electrophoretically Painted Aluminum Alloy Profiles)
/ No: SHAM20210301354 (Powder Sprayed Aluminum Alloy Profiles)
/ No: SHAM20210301355 (6063-T5 Aluminum Alloy Profiles-Substrates)
/ No: SHAM20210301355 (6061-T6 Aluminum Alloy Profiles-Substrates)
/ No: L22-WT0474ET (Aluminum Alloy Profile)
Model: 5001, 6063-T5



▶ Business License
50 million registered capital



▶ Patent



▶ Test Report



Australian Engineering

ALUMINUN
ZHONGLIAN building excellence every day



01

American



02

American



03

China

ZHONGLIAN Project Case

For over 30 years, ZHONGLIAN has been a design and manufacturer of aluminum extrusions. We have forged invaluable partnerships with industry leaders that enable us to provide our customers with one of the largest selections of standard and specialty aluminum profile and finishes available anywhere. Our commitment is to provide customers with high quality products and service that meets their budgets and schedule.

► Our Clients & Partners

Our business is customer satisfaction. ZHONGLIAN was founded in 1993 with the belief that premium products along with outstanding customer service would pass the test of time. Over 30 years later, we still believe our customers' satisfaction drives the way we do business. Over the years, we have cooperated with overseas customers in more than 70 countries and more than 200 regions

► Our customer testimonials

"ZHONGLIAN could readily provide the sizes, shapes and technical benefits of a thermally advanced profile to meet the environmental demands of this northern project."

- MALCOLM WILDEBOER // United States



▲ United States



▲ Germany



▲ Australian



▲ England



▲ South Africa



▲ Italy



▲ Russia



▲ Isreal

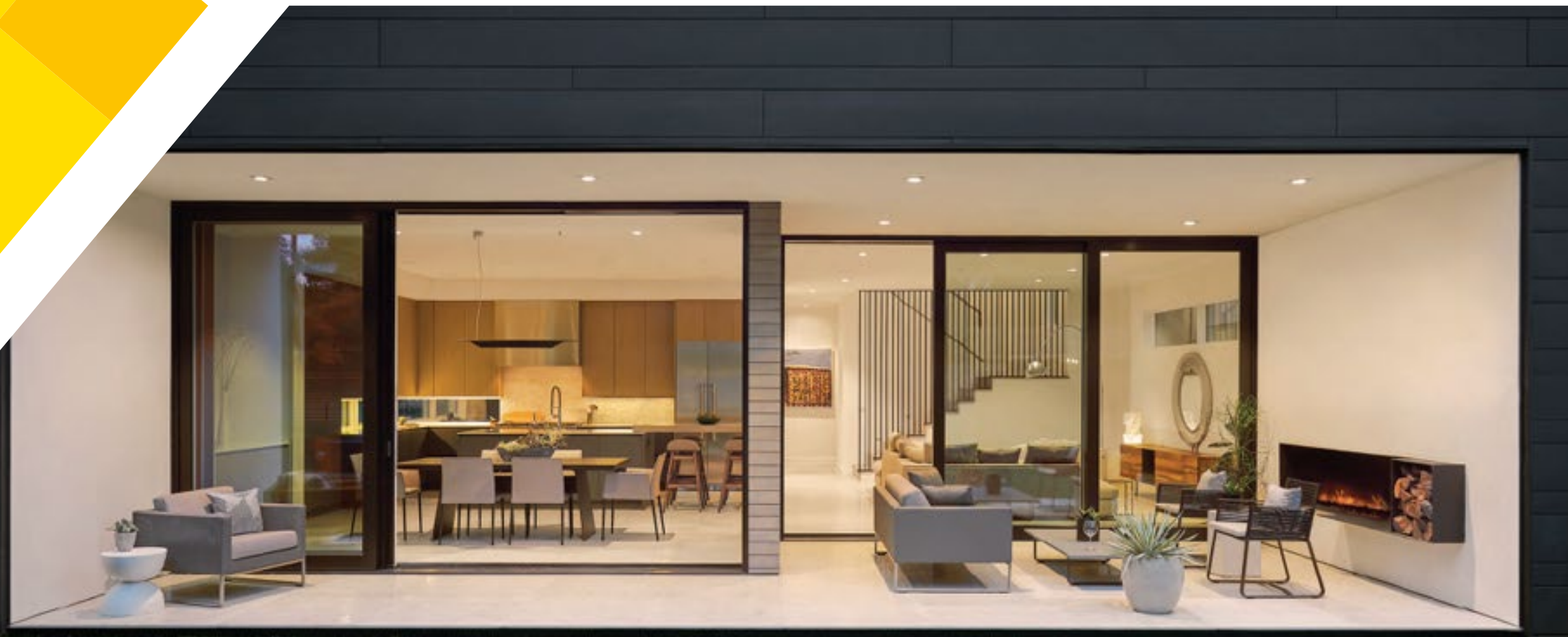

American



Australia



China



On-time delivery

We have enough production capacity to meet the customer's order needs, and the logistics company will be arranged as soon as the order production is completed, ready to deliver to our customers at any time. ZHONGLIAN all supplying world-class products at short lead times.



Quality Inspection

From accessories to finished products by professional design team involved in design, production, improvement, the optimal error range is within 1%. The products will pass the product quality inspection of the ZHONGLIAN factory before delivery. Customers can inspect the goods in person or entrust a professional organization to inspect the goods.



Custom Packaging

It's all in the details. We want to make sure you are receiving the best quality item. Taking an extra precaution of properly packaging the aluminum to protect the finish is just another step ZHONGLIAN handles to ensure quality.



01



02

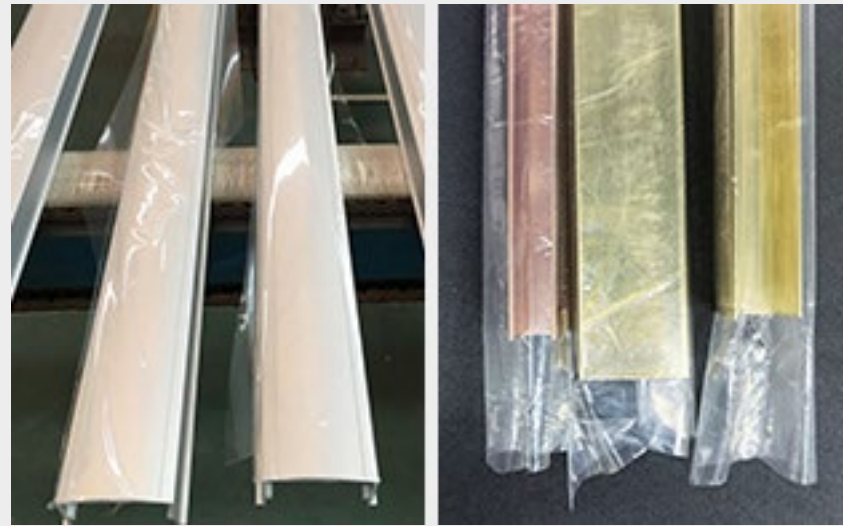

▲ 01 Plastic Film

▲ 02 Polybag



▲ 03 Waterproof Craft Paper

▶ ZHONGLIAN Standard Packaging (3M - 6M)

Long-distance transportation is easy to cause wear and tear on the product, ZHONGLIAN provides high-quality packaging to protect the products.

▶ For aluminum profiles with a length of 3m - 6m, we use 01 Plastic Film or 02 Polybag packaging internally and 03 Waterproof Craft Paper packaging externally to protect the product

▶ 03 Waterproof Craft Paper taking up about 3% - 5% of the gross weight.

/ Contact your ZHONGLIAN representative for further details.

▶ ZHONGLIAN Custom Packaging

ZHONGLIAN provide a variety of special packaging for different customer demands.

/ Extra charge for special packaging / Please kindly inform before mass production

▶ 04 EPE Foam ▶ 06 Wooden box ▶ 07 Woven Bag

▶ 05 Carton and Wooden shelf ▶ 08 Iron Frame

▶ ZHONGLIAN Small Part Aluminum Packaging

▶ Inner Packing : 02 Protective Polybag for each piece

▶ Outer Packing : 07 Carton and Wooden Shelf.

▶ ZHONGLIAN Finished Products Packaging

▶ Inner Packing : 09 PE Foam for each piece

▶ Outer Packing : 10 Wooden Frame for each piece.

04 EPE Foam

05 Wooden box

06 Woven Bag

07 Carton and Wooden shelf



08 Iron Frame

09 PE Foam

10 Wooden Frame



ZHONGLIAN

T-Slot Structural Aluminum Profile

Structural aluminum framing comes in all shapes and sizes, including everything from metric and inch profiles to fasteners, connectors and specialty accessories. We here at ZHONGLIAN are proud to offer you a full range of these supplies and custom structural aluminum extrusions.

ZHONGLIAN also offers a full range of services, including certified CAD design, prototyping, welding, custom extrusions and more. We want to help you make your project as successful as it can be, no matter how big or small the task.

Custom Structural Aluminium Profiles

Whether you're working on a full structural or modular aluminum framing project or a more simple task, ZHONGLIAN has the pieces you need to build a complete and economical solution. If you don't see what you are looking for here in our catalog, please feel free to contact us. We are happy to look into your needs for you.

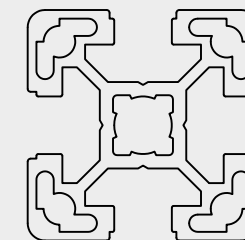



Customized model



Customized model



Customized model



Customized model



Customized model

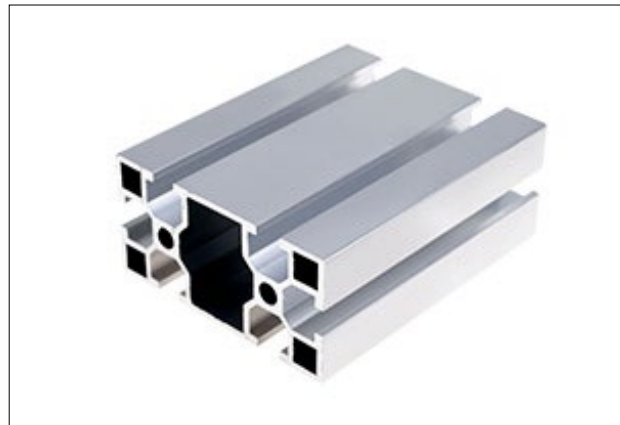

40x80 MM



40x80 MM



30x120 MM



40x80 MM



40x80 MM



40x40 MM



40x40 MM



30x30 MM



40x40 MM



80x80 MM

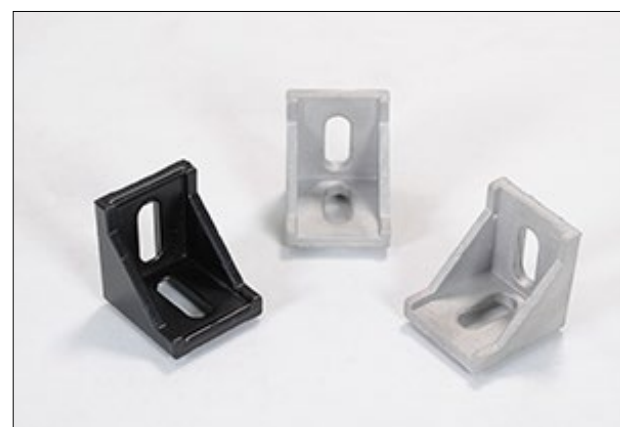

Accessory No.1



Accessory No.2



Accessory No.3



Accessory No.4



Accessory No.5



Accessory No.6



Accessory No.7



Accessory No.8



Accessory No.9



Accessory No.10



Please note:

- / The products in stock are all mill finish. If you need to do surface treatment after you purchase them back, we recommend do powder coating. If your product needs to do anodized , we recommend that you wait a few days and we will re-produce new products for you.
- / The standard length of the aluminum tube in stock is 6 meters. If you need to cut the product to a customized length, please notify in advance before delivery. Different lengths have different cutting prices.
- / The stock quantity will change at any time, please contact the sales staff to verify the quantity before purchasing, the MOQ is 500 kgs
- / The delivery time of T-slot aluminum profile in stock is 2-3 days, if powder coating or anodized is required, the time is 2 weeks.
- / Contact your ZHONGLIAN representative for further details.

Model	Meter Weight (KG / M)	Model	Meter Weight (KG / M)	Model	Meter Weight (KG / M)	Model	Meter Weight (KG / M)	Model	Meter Weight (KG / M)
DY028	2.002	MH-3060Y	1.55	JL-8-4080EA	2.196	DY-1640	1.097	HX-010	0.958
ZEN-50100	5.066	NLS-PA021	4.933	DY170	4.074	YZB037	0.832	YZB100	0.657
LMX-1032	1.017	MH-136	0.468	DS8080	4.264	GW-C010C	2.795	YZB-4040C	1.274

Model	Meter Weight (KG / M)	Model	Meter Weight (KG / M)	Model	Meter Weight (KG / M)	Model	Meter Weight (KG / M)	Model	Meter Weight (KG / M)
SXW-CY-YC014	1.39	YZB124	2.846	YZB170	4.061	YZB124-1	1.804	DS6060	2.556
Model	Meter Weight (KG / M)	Model	Meter Weight (KG / M)	Model	Meter Weight (KG / M)	Model	Meter Weight (KG / M)	Model	Meter Weight (KG / M)
MH-061	2.451	CR63060-1	1.509	CR66060	2.478	MH-1038	1.716	CY-2040H-1	0.468
Model	Meter Weight (KG / M)	Model	Meter Weight (KG / M)	Model	Meter Weight (KG / M)	Model	Meter Weight (KG / M)	Model	Meter Weight (KG / M)
YZB135	3.783	YZB169	2.46	YS-188	0.468	ZWXY-11	1.071	GW-C010B	3.381

Model	Meter Weight (KG / M)	Model	Meter Weight (KG / M)	Model	Meter Weight (KG / M)	Model	Meter Weight (KG / M)	Model	Meter Weight (KG / M)
GW-C015	4.109	GY-2040H-2	0.807	ZEN-5050	2.583	SXW-GW-8080X5	6.36	YZB305	0.806
Model	Meter Weight (KG / M)	Model	Meter Weight (KG / M)	Model	Meter Weight (KG / M)	Model	Meter Weight (KG / M)	Model	Meter Weight (KG / M)
GY2317	1.217	GW-C001	1.596	CY-2020A	0.345	DY017	1.202	CR6R8840	3.456
Model	Meter Weight (KG / M)	Model	Meter Weight (KG / M)	Model	Meter Weight (KG / M)	Model	Meter Weight (KG / M)	Model	Meter Weight (KG / M)
JB-182	1.22	SXW-CY-YC014	1.39	YZB124-2	1.67	GW-C016	1.282	GY-F47	1.031

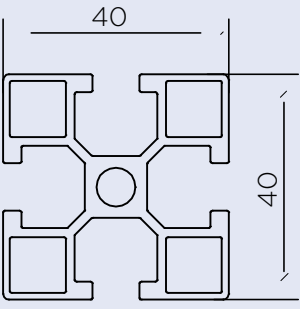
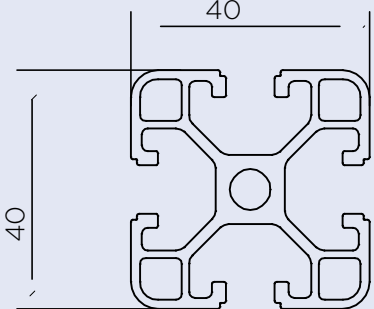
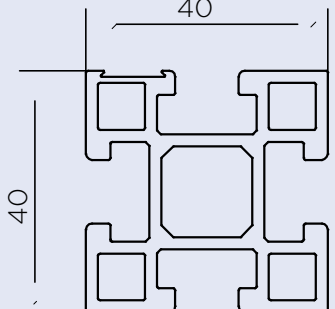
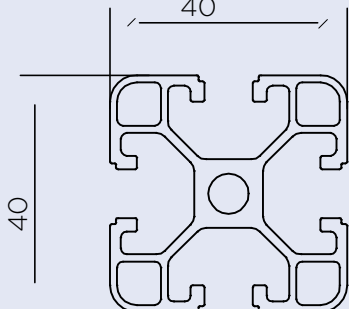
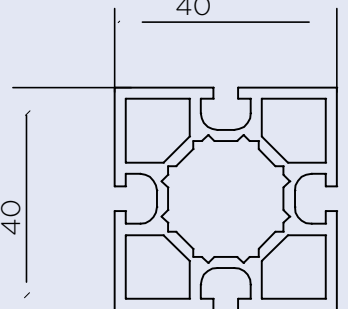
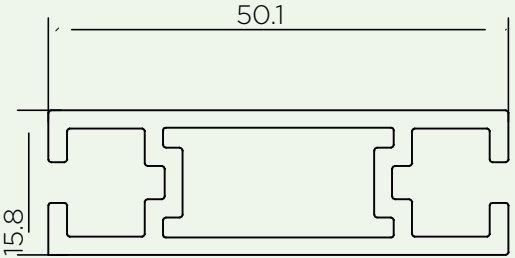
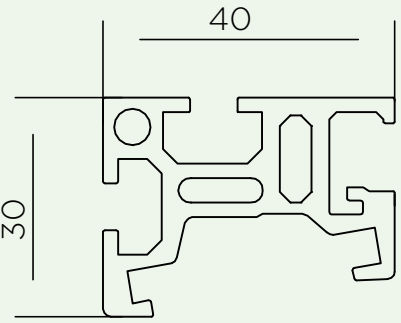
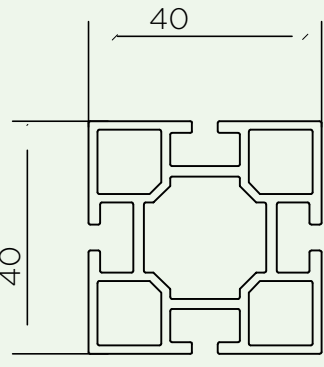
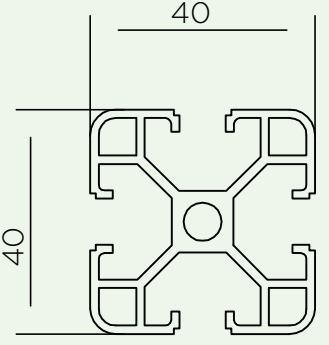
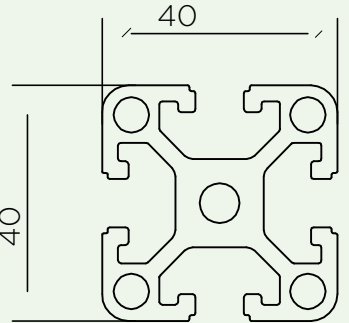
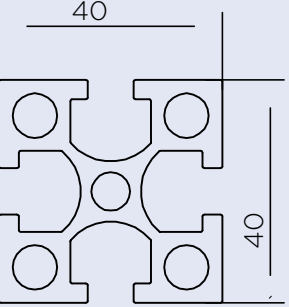
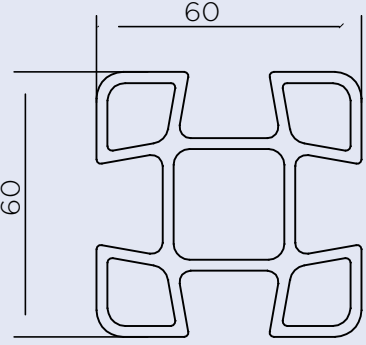
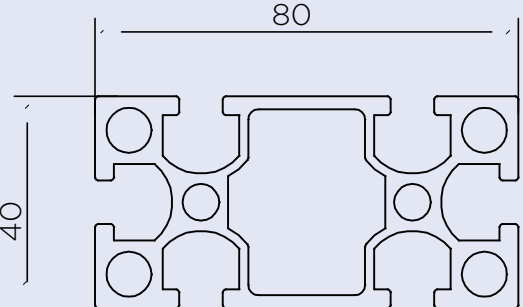
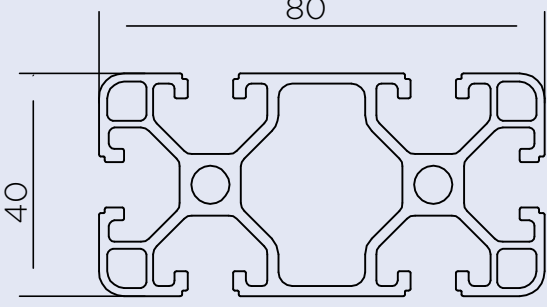
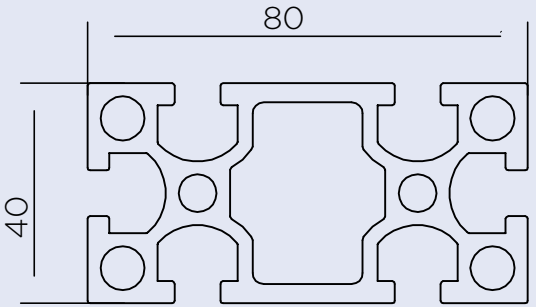
Model	Meter Weight (KG / M)	Model	Meter Weight (KG / M)	Model	Meter Weight (KG / M)	Model	Meter Weight (KG / M)	Model	Meter Weight (KG / M)
SXW-DY017	1.202	YZB-4040CA	1.1	CY-GY4040AB	1.456	YZB-4040C	1.19	HH-18	1.395
									
Model	Meter Weight (KG / M)	Model	Meter Weight (KG / M)	Model	Meter Weight (KG / M)	Model	Meter Weight (KG / M)	Model	Meter Weight (KG / M)
HH-17	0.8	SXW-8006	1.076	WL1905	1.194	YL-002	1.15	DY-4040-AT22	1.83
									
Model	Meter Weight (KG / M)	Model	Meter Weight (KG / M)	Model	Meter Weight (KG / M)	Model	Meter Weight (KG / M)	Model	Meter Weight (KG / M)
YZB124-1	1.804	CF-FB101-1	2.535	GW-C010A	2.65	JC-8-4080EA	2.187	GW-C010B	3.17
									

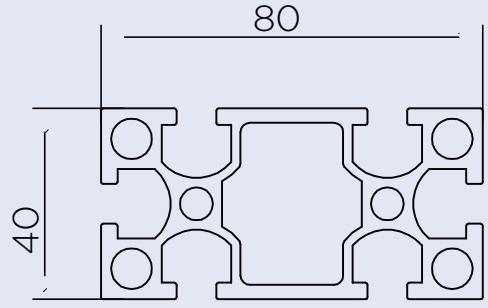
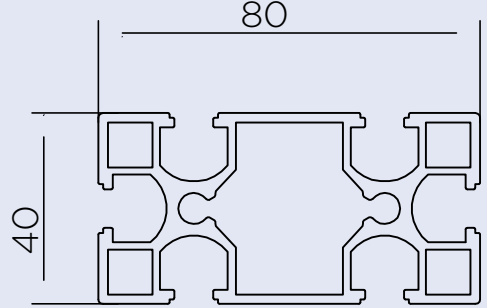
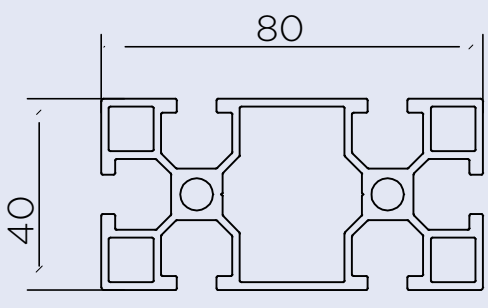
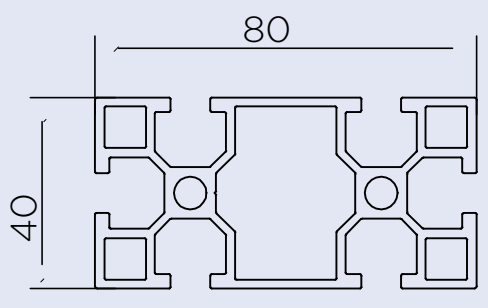
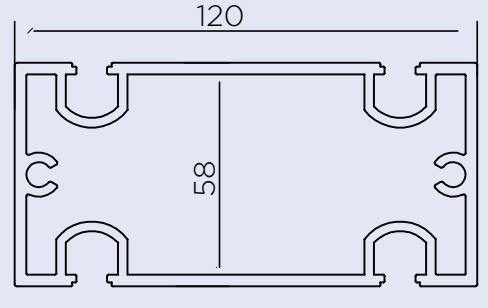
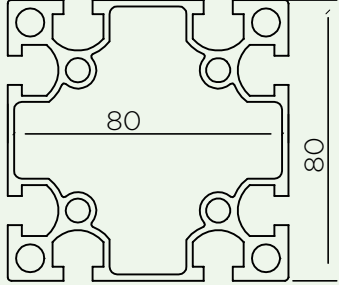
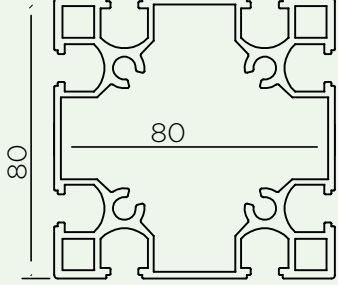
Model	Meter Weight (KG / M)	Model	Meter Weight (KG / M)	Model	Meter Weight (KG / M)	Model	Meter Weight (KG / M)	Model	Meter Weight (KG / M)
GW-C010C	2.795	LH-CY022	2.23	SXW-DY021A	2.04	SXW-DY021	2.263	YXC-1056-L	3.73
									
Model	Meter Weight (KG / M)	Model	Meter Weight (KG / M)						
GW-C015	3.73	SXW-025	3.326						
									

OUR OFFICIAL WEBSITES



Main Brand Website - <https://www.nhzhonglian.com/>
Sub Brand Website - <https://www.pailian-aluminium.com/>



Main Brand Alibaba Website1 - <https://chinaaluminium.en.alibaba.com/>
Main Brand Alibaba Website2 - <https://nhzhonglian.en.alibaba.com/>
Sub Brand Alibaba Website1 - <https://apailian.en.alibaba.com/>
Sub Brand Alibaba Website2 - <https://nhzc.en.alibaba.com/>



Facebook - <https://www.facebook.com/ZhonglianAluminumProfile>



Youtube - <https://www.youtube.com/channel/UCmyQfAjHqXu6QGy6l2p6uoA>



Linkedin - <https://www.linkedin.cn/incareer/in/ivy-zheng-0a204a12a>



Instagram - <https://www.instagram.com/zhonglian.888/>



Twitter - <https://twitter.com/LianZhong19>



Tiktok - <https://vt.tiktok.com/ZSdsJ1omo/>



Brand Website



Brand Website



Alibaba Shop 1



Alibaba Shop 2



Alibaba Shop 3



Alibaba Shop 4



Facebook



Youtube



Linkedin



Instagram



Twitter



Tiktok



CHINA
HEADQUARTERS FACTORY

No.2 Guohong Road,
Changhongling Industrial Park (Phase II),
Shishan Town, Nanhai District, Foshan City,
Guangdong Province, China.
Tel.: +86-13543617955
Fax: 0757-81792001
E-mail: 18@zl-alu.com

CHINA
BRANCH FACTORY (CNC SERVICE)

No. 22, Yanfeng Industrial Park,
Shishan Town, Nanhai District, Foshan City,
Guangdong Province, China.
Tel.: +86-13543617955
E-mail: 18@zl-alu.com

INTERNATIONAL TRADE
HEAD OFFICES & SHOWROOM

18 / F, Aluminum Association Building,
Guangfo Commercial City, Lingnan Road,
Dali Town, Nanhai District, Foshan City,
Guangdong Province, China.
Tel.: +86-13543617955
Fax: 0757-81823028
E-mail: 18@zl-alu.com



ZHONGLIAN
Aluminum Profiles